

# Group 2 Gear Pumps

## Technical Information

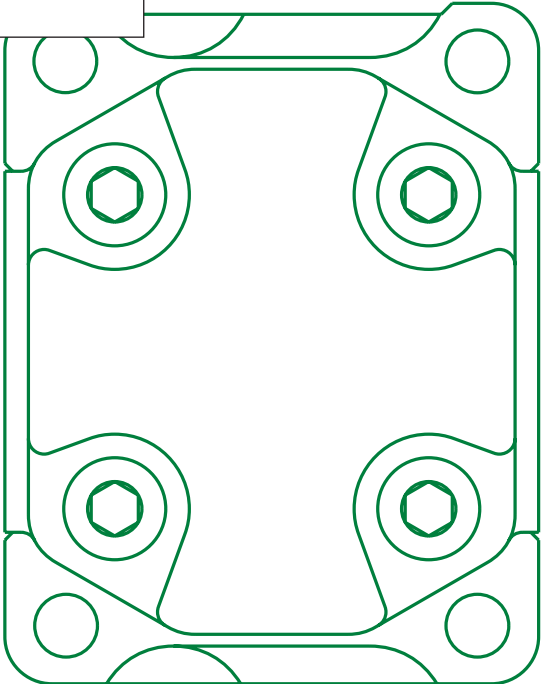
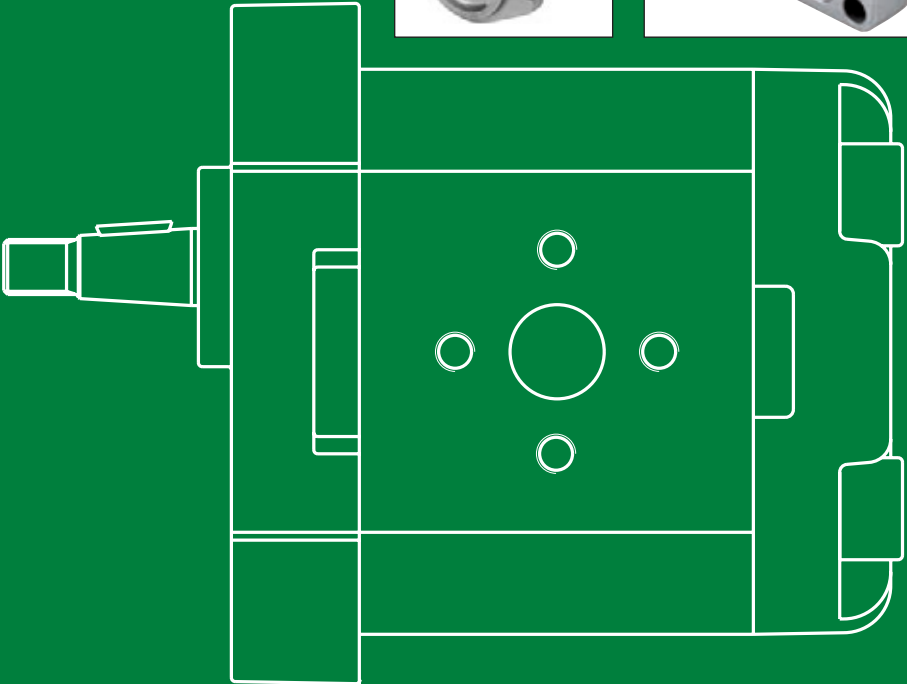
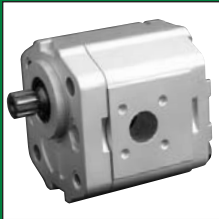
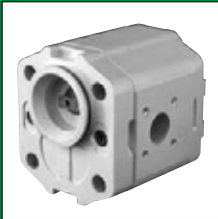
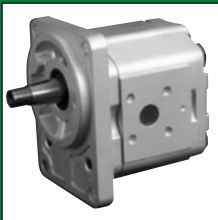

# Group 2 Gear Pumps

## Technical Information

### General Information

#### History of revisions

##### *Table of revisions*

Date	Page	Changed	Rev.
28, June 2010	-	First edition	A

#### Reference documents

##### *Literature reference for gear products*

Title	Type	Order number
General Aluminum Gear Pumps and Motors	Technical Information	L1016238
Group 1 Gear Pumps	Technical Information	L1016399
Group 3 Gear Pumps	Technical Information	L1016456
Group 1, 2 and 3 Gear Motors	Technical Information	L1016082
Hydraulic Fluids and Lubricants	Technical Information	L1021414
Experience with Biodegradable Hydraulic Fluids	Technical Information	L1021903

© 2010 Turolla OpenCircuitGear™. All rights reserved.

Turolla OCG accepts no responsibility for possible errors in catalogs, brochures and other printed material. Turolla OCG reserves the right to alter its products without prior notice. This also applies to products already ordered provided that such alterations can be made without affecting agreed specifications. All trademarks in this material are properties of their respective owners. Sauer-Danfoss, Turolla, Turolla OpenCircuitGear, Turolla OCG, OpenCircuitGear, Fast Lane and PLUS+1 are trademarks of the Sauer-Danfoss Group.

# Group 2 Gear Pumps Technical Information Contents

<b>General Information</b>	Overview .....	4
	Pump design .....	5
	Features .....	5
	Pump displacements .....	5
	Group 2 gear pumps` attributes.....	5
	Gear pump in circuit.....	6
<b>Technical Data</b>	Technical data.....	7
<b>Product Coding</b>	Model code.....	8
<b>Determination of Nominal Pump Sizes</b>	Based on SI units/Based on US units .....	10
<b>System Requirements</b>	Pressure.....	11
	Speed .....	11
	Hydraulic fluids .....	12
	Temperature and viscosity.....	12
	Filtration.....	13
	Filters .....	13
	Selecting a filter.....	13
	Reservoir .....	14
	Line sizing .....	14
	Pump drive .....	15
	Pump drive data form.....	16
	Pump life.....	17
	Sound levels .....	18
<b>Pump Performance</b>	Performance graphs.....	19
<b>Product Options</b>	Flange, shaft and ports configurations .....	22
	Mounting flanges.....	24
	Shaft options.....	24
	Inlet/Outlet port configurations .....	25
	Pumps with integral relief valve • SNP2EN and SNP2IN .....	26
	Integral relief valve schematics.....	26
	Variant codes for ordering integral relief valves.....	27
	Integral relief valve covers SNP2IN .....	28
	Outrigger bearing assembly .....	29
	Available configurations .....	29
	Auxiliary mounting pads .....	32
	Pump ports.....	34
<b>Dimensions</b>	SNP2NN – 01DA, 01FA and 01BA.....	35
	SNP2NN – 02DB and 02AA.....	36
	SNP2NN – 03CA .....	37
	SNP2NN – 04/05DB and 04/05AA .....	38
	SKP2NN – 06SB and SNP2NN – 06SA, 06GA .....	39
	SNP2NN – 06SA..BxBxYY../.....	40
	SNP2NN – 09BJ.....	41
	SNP2NN – A9BJ .....	42

## Group 2 Gear Pumps Technical Information General Information

### Overview

Turolla OCG aluminum gear pumps are ideal for a wide range of applications for:

- **Small vehicles**, such as aerial lifts, greens and fairway mowers and electric forklifts. These needs are served by the pumps in the SKP2NN range with integral valves and pressure balanced design for high efficiency, and extruded aluminum bodies for high strength.
- **Medium and large off-highway vehicles**, like tractors, backhoe loaders, dumpers, and telescopic handlers, we offer the SNP2NN.

Many combinations of the pumps mentioned are available as multiple units made to fit any need. Turolla OCG provides standard pumps for use in industrial applications, including power packs.

*Group 2 gear pumps representatives:*

SKP2NN 06SA

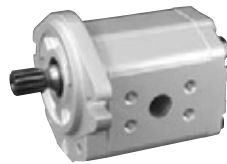

SNP2NN 02AA

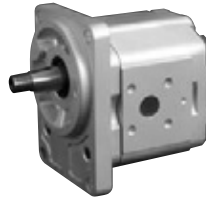

SNP2NN 04DA



SNP2NN 03CA



## Group 2 Gear Pumps Technical Information General Information

### Pump design

Turolia OCG high performance gear pumps are fixed displacement pumps which consist of the pump housing, drive gear, driven gear, DU bushings, rear cover and front flange, shaft seal and inner/outer seals, as shown in *the image below*.

The pressure balanced design of the pumps provides high efficiency for the entire series.

The SNP2NN pump accommodates SAE 9-tooth and the SKP2NN is a special version of the SNP2NN. It is designed to accommodate an SAE 9T 20/40 DP tooth splined shaft for higher torque applications.

SNP2NN 06SA cut-away

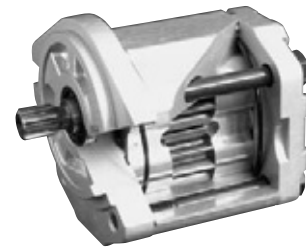

### Features

#### Group 2 gear pumps` attributes

- Wide range of displacements from 3.9 to 25.2 cm<sup>3</sup>/rev [from 0.24 to 1.54 in<sup>3</sup>/rev]
- Continuous pressure rating up to 250 bar [3625 psi]
- Speeds up to 4000 min<sup>-1</sup> (rpm)
- SAE, DIN and European standard mounting flanges and shafts
- Compact, lightweight
- Multiple pump configurations in combination with SNP1NN, SNP2NN and SNP3NN
- Quiet operation
- Available with integral relief valve

### Pump displacements

Quick reference chart for *pump displacements vs. rated pressure*

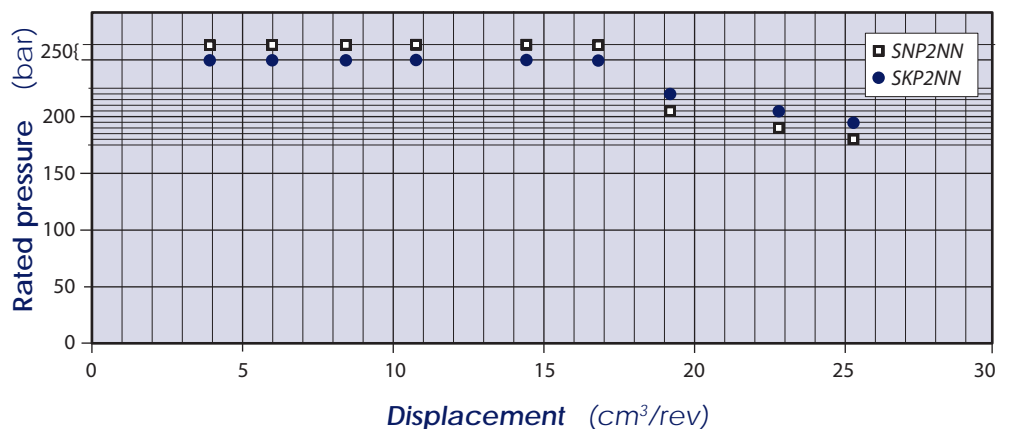

## Group 2 Gear Pumps Technical Information General Information

### Gear pump in circuit

This typical circuit shows an SNP2NN gear pump driving an SNM2NN gear motor through a system pressure control valve. The system pressure control valve regulates motor speed based on input from the wax capsule thermal sensor. Discharge from the gear motor is then returned to the reservoir through a heat exchanger, which is equipped with a bypass check valve. Oil in this circuit is cleaned by a return line filter placed between the heat exchanger and the reservoir. A suction screen in the reservoir covers the inlet line.

#### Hydraulic schematic example

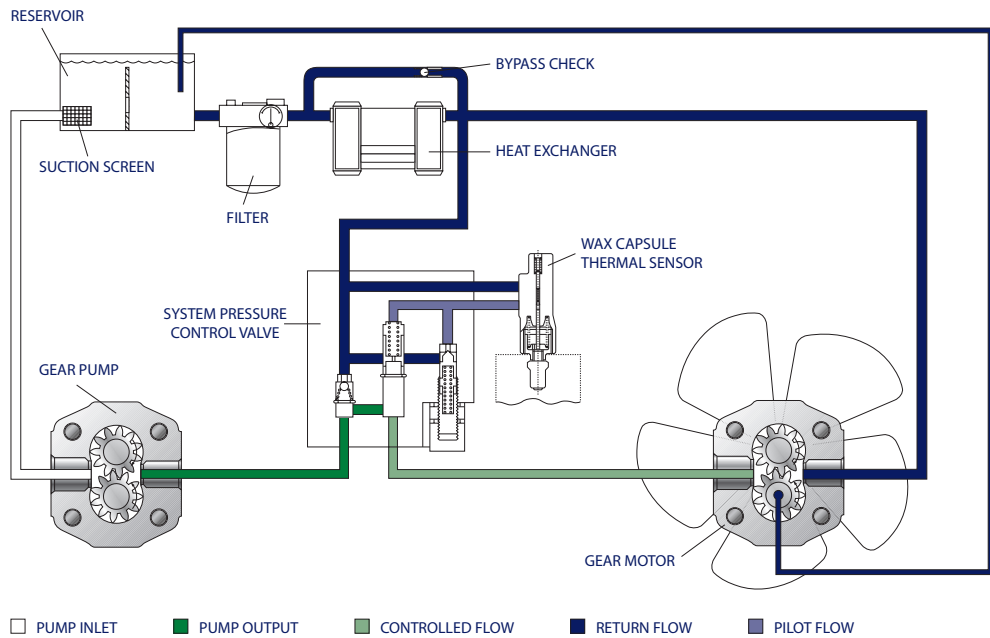

## Technical data

### Technical data

Frame size		4,0	6,0	8,0	011	014	017	019	022	025
Displacement	cm <sup>3</sup> /rev	3.9	6.0	8.4	10.8	14.4	16.8	19.2	22.8	25.2
	[in <sup>3</sup> /rev]	[0.24]	[0.37]	[0.51]	[0.66]	[0.88]	[1.02]	[1.17]	[1.39]	[1.54]
<b>SNP2NN</b>										
Peak pressure	bar [psi]	280 [4060]	280 [4060]	280 [4060]	280 [4060]	280 [4060]	280 [4060]	230 [3335]	200 [2900]	175 [2638]
Rated pressure		250 [3625]	250 [3625]	250 [3625]	250 [3625]	250 [3625]	250 [3625]	250 [3625]	210 [3045]	180 [2610]
Minimum speed at 0-100 bar	min <sup>-1</sup> (rpm)	600	600	600	500	500	500	500	500	500
Minimum speed at 100-180 bar		1200	1200	1000	800	750	750	700	700	700
Min. speed at 180 bar to rated pressure		1400	1400	1400	1200	1000	1000	1000	800	–
Maximum speed		4000	4000	4000	4000	3500	3000	3000	3000	3000
<b>SKP2NN</b>										
Peak pressure	bar [psi]	280 [4060]	280 [4060]	280 [4060]	280 [4060]	280 [4060]	280 [4060]	260 [3770]	230 [3335]	200 [2900]
Rated pressure		250 [3625]	250 [3625]	250 [3625]	250 [3625]	250 [3625]	250 [3625]	250 [3625]	240 [3480]	210 [3045]
Minimum speed at 0-100 bar	min <sup>-1</sup> (rpm)	600	600	600	500	500	500	500	500	500
Minimum speed at 100-180 bar		1200	1200	1000	800	750	750	700	700	700
Min. speed at 180 bar to rated pressure		1400	1400	1400	1200	1000	1000	1000	800	800
Maximum speed		4000	4000	4000	4000	3500	3000	3000	3000	3000
<b>Both (SNP2NN, SKP2NN)</b>										
Weight	kg [lb]	2.3 [5.1]	2.4 [5.3]	2.5 [5.5]	2.7 [5.8]	2.9 [6.3]	3.0 [6.5]	3.1 [6.7]	3.2 [7.0]	3.3 [7.3]
Moment of inertia of rotating components	x 10 <sup>-6</sup> kg·m <sup>2</sup> [x 10 <sup>-6</sup> lb·ft <sup>2</sup> ]	21.3 [505]	26.5 [629]	32.4 [769]	38.4 [911]	47.3 [1122]	53.3 [1265]	59.2 [1405]	68.1 [1616]	74.1 [1758]
Theoretical flow at maximum speed	l/min [US gal/min]	15.6 [4.1]	24.0 [6.3]	33.6 [8.9]	43.2 [11.4]	50.4 [13.3]	50.4 [13.3]	57.6 [15.2]	68.4 [18.0]	75.6 [20.0]

1 kg·m<sup>2</sup> = 23.68 lb·ft<sup>2</sup>

### ⚠ Caution

The rated and peak pressure mentioned are for pumps with flanged ports only. When threaded ports are required a de-rated performance has to be considered. To verify the compliance of an high pressure application with a threaded ports pump apply to a Turola OCG representative.

# Group 2 Gear Pumps

## Technical Information

### Product Coding

#### Model code



#### A Type

<b>SNP2NN</b>	Standard gear pump
<b>SNP2IN</b>	Standard gear pump, internal drain, integrated relief valve
<b>SNP2EN</b>	Standard gear pump, external drain, integrated relief valve
<b>SNC2NN</b>	Standard gear pump, inlet/outlet in the cover
<b>SKP2NN</b>	High torque gear pump
<b>SKP2IN</b>	High torque gear pump, internal drain, integrated relief valve
<b>SKP2EN</b>	High torque gear pump, external drain, integrated relief valve
<b>SKC2NN</b>	High torque gear pump, inlet/outlet in the cover
<b>SHP2NN</b>	High pressure gear pump

#### B Displacement

<b>4,0</b>	3.9 cm <sup>3</sup> /rev [0.24 in <sup>3</sup> /rev]
<b>6,0</b>	6.0 cm <sup>3</sup> /rev [0.37 in <sup>3</sup> /rev]
<b>8,0</b>	8.4 cm <sup>3</sup> /rev [0.51 in <sup>3</sup> /rev]
<b>011</b>	10.8 cm <sup>3</sup> /rev [0.66 in <sup>3</sup> /rev]
<b>014</b>	14.4 cm <sup>3</sup> /rev [0.88 in <sup>3</sup> /rev]
<b>017</b>	16.8 cm <sup>3</sup> /rev [1.02 in <sup>3</sup> /rev]
<b>019</b>	19.2 cm <sup>3</sup> /rev [1.17 in <sup>3</sup> /rev]
<b>022</b>	22.8 cm <sup>3</sup> /rev [1.39 in <sup>3</sup> /rev]
<b>025</b>	25.2 cm <sup>3</sup> /rev [1.54 in <sup>3</sup> /rev]

#### C Direction of rotation

<b>R</b>	Right (Clockwise)
<b>L</b>	Left (Counterclockwise)

#### D Version

<b>N</b>	Standard gear pump
<b>2</b>	Standard gear pump, big shaft

Legend:	
●	Standard
○	Optional
-	Not Available

#### E Mounting flange / drive gear

Code	Description (Type of flange • Type of drive gear • Preferred ports for configuration)	SNP2NN	SNP2IN	SNP2EN	SNC2NN	SKP2NN	SKP2IN	SKP2EN	SKC2NN	SHP2NN
<b>01FA</b>	European four bolts flange • Parallel shaft 15 mm [0.591 in] • European flanged ports	●	●	-	-	-	-	-	-	-
<b>01BA</b>	European four bolts flange • Tapered 1:8 shaft • European flanged ports	●	●	-	●	-	-	-	-	●
<b>01DA</b>	European four bolts flange • Splined 15T 12x10 shaft • European flanged ports	●	●	●	-	-	-	-	-	●
<b>02AA</b>	German four bolts PTO flange • Tapered 1:5 shaft • German flanged ports	●	●	-	-	-	-	-	-	●
<b>02DB</b>	German four bolts PTO flange • DIN splined shaft • German flanged ports	●	●	-	-	-	-	-	-	-
<b>03CA</b>	Turolla OCG Tang flange • Turolla OCG Tang shaft • German flanged ports	●	●	●	-	-	-	-	-	-
<b>91DB</b>	European four bolts flange Outrigger bearing • Tapered 1:8 shaft key 4 • European flanged ports	●	-	-	-	-	-	-	-	-
<b>9ADB</b>	European four bolts flange Outrigger bearing • Tapered 1:8 shaft key 3.2 • European flanged ports	●	-	-	-	-	-	-	-	-
<b>94DB</b>	German two bolts PTO flange (Deutz) Outrigger bearing • Tapered 1:5 shaft • German flanged ports	●	-	-	-	-	-	-	-	-
<b>9JDB</b>	SAE A flange Outrigger bearing • Parallel shaft 19.05mm [0.750 in] • SAE O-ring boss ports	●	-	-	-	-	-	-	-	-
<b>04AA</b>	German two bolts PTO flange (Deutz) • Tapered 1:5 shaft • German flanged ports	●	-	-	-	-	-	-	-	●
<b>04DB</b>	German two bolts PTO flange (Deutz) • DIN splined shaft • German flanged ports	●	-	-	-	-	-	-	-	●
<b>05AA</b>	German two bolts PTO flange (Deutz) • Tapered 1:5 shaft • German flanged ports	●	-	-	-	-	-	-	-	●
<b>05DB</b>	German two bolt PTO flange (Deutz) • DIN splined shaft • German flanged ports	●	-	-	-	-	-	-	-	●
<b>06GA</b>	SAE A flange • Parallel shaft 15.875 mm [0.625 in] • SAE O-ring boss ports	●	-	-	-	-	-	-	-	-
<b>06SA</b>	SAE A flange • SAE splined 9T shaft • SAE O-ring boss ports	●	●	●	-	-	-	-	-	-
<b>06SB</b>	SAE A flange • SAE splined 11T shaft • SAE O-ring boss ports	-	-	-	-	●	●	●	●	-
<b>09BJ</b>	Perkins 4.236 timing case flange • Tapered 1:8 shaft • German std port X pattern ports	●	-	-	-	-	-	-	-	-
<b>A9BJ</b>	Perkins 900 series flange • Tapered 1:8 shaft • German std port X pattern ports	●	-	-	-	-	-	-	-	-



## Group 2 Gear Pumps Technical Information Product Coding

Model code  
(continued)

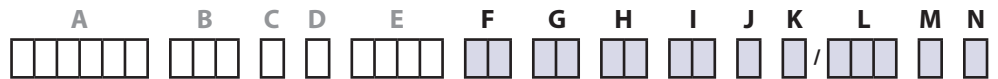

### F Rear cover

<b>P1</b>	Standard cover for pump
<b>P3</b>	Cover for 03 flange only
<b>C1</b>	Front BSP ports: Inlet 3/4 GAS Outlet 1/2 GAS
<b>C6</b>	Front SAE thd ports: Inlet 1 1/16-12UN-2B Outlet 7/8-14UNF-2B
<b>E1</b>	Cover for RV external drain 3/8 GAS
<b>E3</b>	Cover for RV ext. drain 3/8 GAS holes M5
<b>E6</b>	Cover for RV ext. drain 3/4 -16UNF-2B
<b>I1</b>	Cover for RV internal drain
<b>I3</b>	Cover for RV int. drain for 03 flange only

### G Inlet port

### H Outlet port

<b>B5</b>	15x35xM6	Flanged port 4 threaded holes in X pattern, in center or off-set of body
<b>B6</b>	15x40xM6	
<b>B7</b>	20x40xM6	
<b>BB</b>	27x55xM8	
<b>C2</b>	12x26xM5	Flanged port 4 threaded holes in + pattern (European standard ports)
<b>C3</b>	13,5x30xM6	
<b>C5</b>	13,5x40xM8	
<b>C7</b>	20x40xM8	
<b>C8</b>	23,5x40xM8	
<b>D4</b>	M16x1,5	Threaded metric port
<b>D5</b>	M18x1,5	
<b>D7</b>	M22x1,5	
<b>D9</b>	M26x1,5	
<b>E3</b>	1/16-18UNF	
<b>E4</b>	3/4-16UNF	
<b>E5</b>	7/8-14UNF	
<b>E6</b>	1 1/16-12UN	
<b>E8</b>	1 5/16-12UN	
<b>F3</b>	3/8 GAS	Threaded GAS (BSPP) port
<b>F4</b>	1/2 GAS	
<b>F5</b>	3/4 GAS	
<b>F6</b>	1 GAS	
<b>H5</b>	M18x1,5	Threaded metric port ISO 6149
<b>H7</b>	M22x1,5	
<b>H8</b>	M27x2	
<b>H9</b>	M33x2	

### I Port position and variant body

<b>NN</b>	Standard from catalogue
<b>YY</b>	Port Bx-Bx for SAE flange off-set from center of body as per catalogue
<b>ZZ</b>	Port Bx-Bx in center of body

### J Sealing

<b>N</b>	Standard Buna seal
<b>A</b>	Without shaft seal
<b>B</b>	VITON seal
<b>L</b>	Std. shaft seal turned over assembled

### K Screws

<b>N</b>	Standard screws
<b>A</b>	Galvanized screws + nut-washers
<b>B</b>	DACROMET/GEOMET screws

### L Set valve

<b>NNN</b>	No valve
<b>V**</b>	Integral relief valve pressure setting

### M Marking

<b>N</b>	Standard marking
<b>A</b>	Standard marking + Customer code
<b>Z</b>	Without marking

### N Mark position

<b>N</b>	Standard marking position
<b>A</b>	Mark on the bottom ref. to drive gear

## Group 2 Gear Pumps Technical Information Determination of Nominal Pump Sizes

### Determination of nominal pump sizes

Use these formulae to determine the nominal pump size for a specific application.

#### Based on SI units

#### Based on US units

*Output flow*  $Q = \frac{V_g \cdot n \cdot \eta_v}{1000} \quad \text{l/min}$

$Q = \frac{V_g \cdot n \cdot \eta_v}{231} \quad \text{[US gal/min]}$

*Input torque*  $M = \frac{V_g \cdot \Delta p}{20 \cdot \pi \cdot \eta_m} \quad \text{N}\cdot\text{m}$

$M = \frac{V_g \cdot \Delta p}{2 \cdot \pi \cdot \eta_m} \quad \text{[lbf}\cdot\text{in]}$

*Input power*  $P = \frac{M \cdot n}{9550} = \frac{Q \cdot \Delta p}{600 \cdot \eta_t} \quad \text{kW}$

$P = \frac{M \cdot n}{63.025} = \frac{Q \cdot \Delta p}{1714 \cdot \eta_t} \quad \text{[hp]}$

*Variables:* SI units [US units]

$V_g$	= Displacement per rev.	$\text{cm}^3/\text{rev}$ [ $\text{in}^3/\text{rev}$ ]
$p_{\text{HD}}$	= Outlet pressure	bar [psi]
$p_{\text{ND}}$	= Inlet pressure	bar [psi]
$\Delta p$	= $p_{\text{HD}} - p_{\text{ND}}$	bar [psi]
$n$	= Speed	$\text{min}^{-1}$ (rpm)
$\eta_v$	= Volumetric efficiency	
$\eta_m$	= Mechanical (torque) efficiency	
$\eta_t$	= Overall efficiency ( $\eta_v \cdot \eta_m$ )	

## Group 2 Gear Pumps Technical Information System Requirements

### Pressure

The inlet vacuum must be controlled in order to realize expected pump life and performance. The system design must meet inlet pressure requirements during all modes of operation. Expect lower inlet pressures during cold start. It should improve quickly as the fluid warms.

**Peak pressure** is the highest intermittent pressure allowed. The relief valve overshoot (reaction time) determines peak pressure. It is assumed to occur for less than 100 ms. *The illustration to the right* shows peak pressure in relation to rated pressure and reaction time (100 ms maximum).

**Rated pressure** is the average, regularly occurring, operating pressure that should yield satisfactory product life. The maximum machine load demand determines rated pressure. For all systems, the load should move below this pressure.

**System pressure** is the differential of pressure between the outlet and inlet ports. It is a dominant operating variable affecting hydraulic unit life. High system pressure, resulting from high load, reduces expected life. System pressure must remain at, or below, rated pressure during normal operation to achieve expected life.

### Inlet pressure

<b>Max. continuous vacuum</b>	bar abs. [in. Hg]	0.8 [23.6]
<b>Max. intermittent vacuum</b>		0.6 [17.7]
<b>Max. pressure</b>		3.0 [88.5]

### Time versus pressure

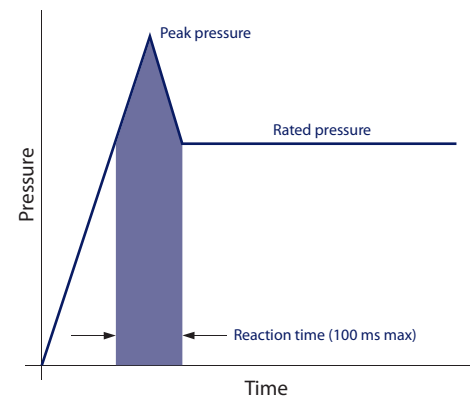

### Speed

**Maximum speed** is the limit recommended by Turolia OCG for a particular gear pump when operating at rated pressure. It is the highest speed at which normal life can be expected.

The lower limit of operating speed is the **minimum speed**. It is the lowest speed at which normal life can be expected. The minimum speed increases as operating pressure increases. When operating under higher pressures, a higher minimum speed must be maintained, as illustrated to the right.

### Speed versus pressure

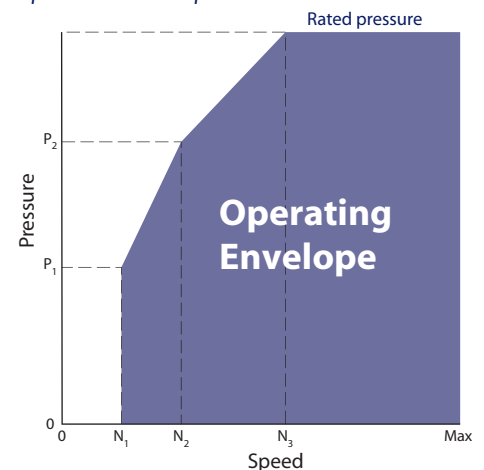

Where:

$N_1$  = Minimum speed at 100 bar

$N_2$  = Minimum speed at 180 bar

$N_3$  = Minimum speed at rated pressure

## Group 2 Gear Pumps Technical Information System Requirements

### Hydraulic fluids

Ratings and data for SNP2NN, SHP2NN and SKP2NN gear pumps are based on operating with premium hydraulic fluids containing oxidation, rust, and foam inhibitors. These fluids must possess good thermal and hydrolytic stability to prevent wear, erosion, and corrosion of internal components. They include:

- Hydraulic fluids following DIN 51524, part 2 (HLP) and part 3 (HVLP) specifications
- API CD engine oils conforming to SAE J183
- M2C33F or G automatic transmission fluids
- Certain agricultural tractor fluids

Use only clean fluid in the pump and hydraulic circuit.

#### ⓘ Caution

**Never mix hydraulic fluids.**

Please see Turolla OCG publication *Hydraulic Fluids and Lubricants Technical Information, L1021414* for more information. Refer to publication *Experience with Biodegradable Hydraulic Fluids Technical Information, L1021903* for information relating to biodegradable fluids.

### Temperature and viscosity

Temperature and viscosity requirements must be concurrently satisfied. Use petroleum / mineral-based fluids.

**High temperature** limits apply at the inlet port to the pump. The pump should run at or below the maximum continuous temperature. The peak temperature is based on material properties. Don't exceed it.

Cold oil, generally, doesn't affect the durability of pump components. It may affect the ability of oil to flow and transmit power. For this reason, keep the temperature at 16 °C [60 °F] above the pour point of the hydraulic fluid.

**Minimum (cold start) temperature** relates to the physical properties of component materials.

**Minimum viscosity** occurs only during brief occasions of maximum ambient temperature and severe duty cycle operation. You will encounter maximum viscosity only at cold start. During this condition, limit speeds until the system warms up. Size heat exchangers to keep the fluid within these limits. Test regularly to verify that these temperatures and viscosity limits aren't exceeded. For maximum unit efficiency and bearing life, keep the fluid viscosity in the recommended viscosity range.

#### Fluid viscosity

<b>Maximum (cold start)</b>		1000 [4600]
<b>Recommended range</b>	mm <sup>2</sup> /s [SUS]	12-60 [66-290]
<b>Minimum</b>		10 [60]

#### Temperature

<b>Minimum (cold start)</b>		-20 [-4]
<b>Maximum continuous</b>	°C [°F]	80 [176]
<b>Peak (intermittent)</b>		90 [194]

## Filtration

### Filters

Use a filter that conforms to Class 22/18/13 of ISO 4406 (or better). It may be on the pump outlet (pressure filtration), inlet (suction filtration), or reservoir return (return-line filtration).

### Selecting a filter

When selecting a filter, please consider:

- Contaminant ingress rate  
(determined by factors such as the number of actuators used in the system)
- Generation of contaminants in the system
- Required fluid cleanliness
- Desired maintenance interval
- Filtration requirements of other system components

Measure filter efficiency with a Beta ratio ( $\beta_x$ ). For:

- Suction filtration, with controlled reservoir ingress, use a  $\beta_{35-45} = 75$  filter
- Return or pressure filtration, use a pressure filtration with an efficiency of  $\beta_{10} = 75$ .

$\beta_x$  ratio is a measure of filter efficiency defined by ISO 4572. It is the ratio of the number of particles greater than a given diameter (" $x$ " in microns) upstream of the filter to the number of these particles downstream of the filter.

### Fluid cleanliness level and $\beta_x$ ratio

<b>Fluid cleanliness level (per ISO 4406)</b>	Class 22/18/13 or better
<b><math>\beta_x</math> ratio (suction filtration)</b>	$\beta_{35-45} = 75$ and $\beta_{10} = 2$
<b><math>\beta_x</math> ratio (pressure or return filtration)</b>	$\beta_{10} = 75$
<b>Recommended inlet screen size</b>	100-125 $\mu\text{m}$ [0.004-0.005 in]

The filtration requirements for each system are unique. Evaluate filtration system capacity by monitoring and testing prototypes.

## Group 2 Gear Pumps Technical Information System Requirements

### Reservoir

The **reservoir** provides clean fluid, dissipates heat, removes entrained air, and allows fluid volume changes associated with fluid expansion and cylinder differential volumes. A correctly sized reservoir accommodates maximum volume changes during all system operating modes. It promotes de-aeration of the fluid as it passes through, and accommodates a fluid dwell-time between 60 and 180 seconds, allowing entrained air to escape.

**Minimum reservoir capacity** depends on the volume required to cool and hold the oil from all retracted cylinders, allowing for expansion due to temperature changes. A fluid volume of 1 to 3 times the pump output flow (per minute) is satisfactory. The minimum reservoir capacity is 125% of the fluid volume.

Install the suction line above the bottom of the reservoir to take advantage of gravity separation and prevent large foreign particles from entering the line. Cover the line with a 100-125 micron screen. The pump should be below the lowest expected fluid level.

Put the return-line below the lowest expected fluid level to allow discharge into the reservoir for maximum dwell and efficient deaeration. A baffle (or baffles) between the return and suction lines promotes deaeration and reduces fluid surges.

### Line sizing

Choose pipe sizes that accommodate minimum fluid velocity to reduce system noise, pressure drops, and overheating. This maximizes system life and performance. Design inlet piping that maintains continuous pump inlet pressure above 0.8 bar absolute during normal operation. The line velocity should not exceed the values in this table:

#### *Maximum line velocity*

<b>Inlet</b>		2.5 [8.2]
<b>Outlet</b>	m/s [ft/sec]	5.0 [16.4]
<b>Return</b>		3.0 [9.8]

Most systems use hydraulic oil containing 10% dissolved air by volume. Under high inlet vacuum conditions the oil releases bubbles. They collapse when subjected to pressure, resulting in cavitation, causing adjacent metal surfaces to erode. **Over-aeration** is the result of air leaks on the inlet side of the pump, and flow-line restrictions. These include inadequate pipe sizes, sharp bends, or elbow fittings, causing a reduction of flow line cross sectional area. This problem will not occur if inlet vacuum and rated speed requirements are maintained, and reservoir size and location are adequate.

## Group 2 Gear Pumps Technical Information System Requirements

### Pump drive

Shaft options for Group 2 gear pumps include tapered, tang, splined, or parallel shafts. They are suitable for a wide range of direct and indirect drive applications for radial and thrust loads.

**Plug-in drives**, acceptable only with a splined shaft, can impose severe radial loads when the mating spline is rigidly supported. Increasing spline clearance does not alleviate this condition.

Use plug-in drives if the concentricity between the mating spline and pilot diameter is within 0.1 mm [0.004 in]. Lubricate the drive by flooding it with oil. A 3-piece coupling minimizes radial or thrust shaft loads.

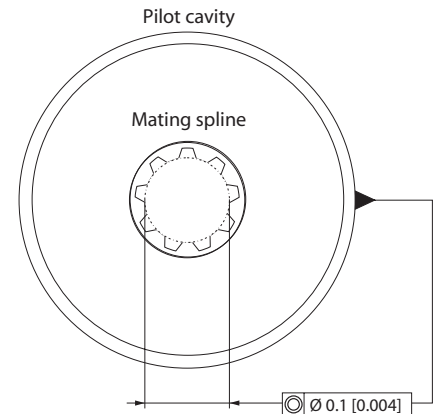

### ⚠ Caution

In order to avoid spline shaft damages it is recommended to use carburized and hardened steel couplings with 80-82 HRA surface hardness.

Allowable **radial shaft loads** are a function of the load position, load orientation, and operating pressure of the hydraulic pump. All external shaft loads have an effect on bearing life, and may affect pump performance.

In applications where external shaft loads can't be avoided, minimize the impact on the pump by optimizing the orientation and magnitude of the load. Use a tapered input shaft; don't use splined shafts for belt or gear drive applications. A spring-loaded belt tension-device is recommended for belt drive applications to avoid excessive tension. Avoid thrust loads in either direction. Contact Turolla OCG if continuously applied external radial or thrust loads occur.

## Group 2 Gear Pumps Technical Information System Requirements

### Pump drive data form

Photocopy this page and fax the complete form to your Turolia OCG representative for an assistance in applying pumps with belt or gear drive. This illustration shows a pump with counterclockwise orientation:

#### Optimal radial load position

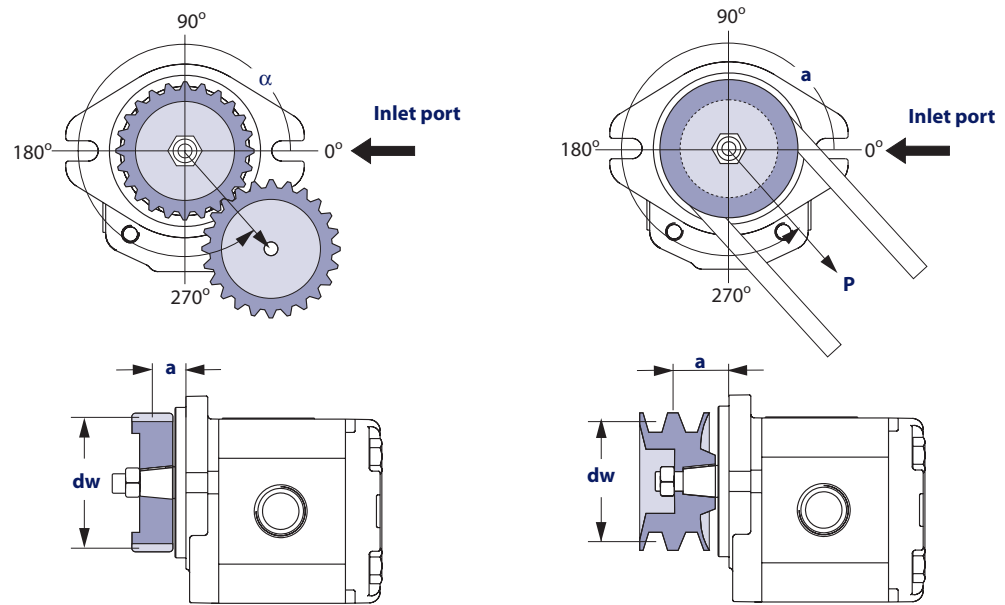

#### Application data

Item	Value	Unit
Pump displacement		cm <sup>3</sup> /rev [in <sup>3</sup> /rev]
Rated system pressure		<input type="checkbox"/> bar <input type="checkbox"/> psi
Relief valve setting		
Pump shaft rotation		<input type="checkbox"/> left <input type="checkbox"/> right
Pump minimum speed		min <sup>-1</sup> (rpm)
Pump maximum speed		
Drive gear helix angle (gear drive only)		degree
Belt type (gear drive only)		<input type="checkbox"/> V <input type="checkbox"/> notch
Belt tension (gear drive only)	<b>P</b>	<input type="checkbox"/> N <input type="checkbox"/> lbf
Angular orientation of gear or belt to inlet port	$\alpha$	degree
Pitch diameter of gear or pulley	<b>d<sub>w</sub></b>	<input type="checkbox"/> mm <input type="checkbox"/> in
Distance from flange to center of gear or pulley	<b>a</b>	



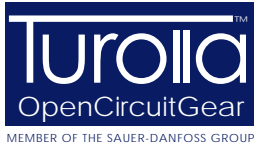

## Group 2 Gear Pumps Technical Information System Requirements

### Pump life

**Pump life** is a function of speed, system pressure, and other system parameters (such as fluid quality and cleanliness).

All Turolla OCG gear pumps use hydrodynamic journal bearings that have an oil film maintained between the gear/shaft and bearing surfaces at all times. If the oil film is sufficiently sustained through proper system maintenance and operating within recommended limits, long life can be expected.

---

$B_{10}$  life expectancy number is generally associated with rolling element bearings. It does not exist for hydrodynamic bearings.

---

High pressure, resulting from high loads, impacts pump life. When submitting an application for review, provide machine duty cycle data that includes percentages of time at various loads and speeds. We strongly recommend a prototype testing program to verify operating parameters and their impact on life expectancy before finalizing any system design.

## Sound levels

Fluid power systems are inherent generators of noise. As with many high power density devices, noise is an unwanted side effect. However, there are many techniques available to minimize noise from fluid power systems. To apply these methods effectively, it is necessary to understand how the noise is generated and how it reaches the listener. The noise energy can be transmitted away from its source as either fluid borne noise (pressure ripple) or as structure borne noise.

**Pressure ripple** is the result of the number of pumping elements (gear teeth) delivering oil to the outlet and the pump's ability to gradually change the volume of each pumping element from low to high pressure. In addition, the pressure ripple is affected by the compressibility of the oil as each pumping element discharges into the outlet of the pump. Pressure pulsations will travel along the hydraulic lines at the speed of sound (about 1400 m/s in oil) until affected by a change in the system such as an elbow fitting. Thus the pressure pulsation amplitude varies with overall line length and position.

**Structure borne noise** may be transmitted wherever the pump casing is connected to the rest of the system. The manner in which one circuit component responds to excitation depends on its size, form, and manner in which it is mounted or supported. Because of this excitation, a system line may actually have a greater noise level than the pump. To reduce this excitation, use flexible hoses in place of steel plumbing. If steel plumbing must be used, clamping of lines is recommended. To minimize other structure borne noise, use flexible (rubber) mounts.

*The accompanying graph* shows typical sound pressure levels for SNP2NN pumps (with SAE A flange, and spline shaft in plug in drive) measured in dB (A) at 1 m [3.28 ft] from the unit in a semi-anechoic chamber. Anechoic levels can be estimated by subtracting 3 dB (A) from these values.

---

Contact your Turolia OCG representative for assistance with system noise control.

---

Sound levels graph

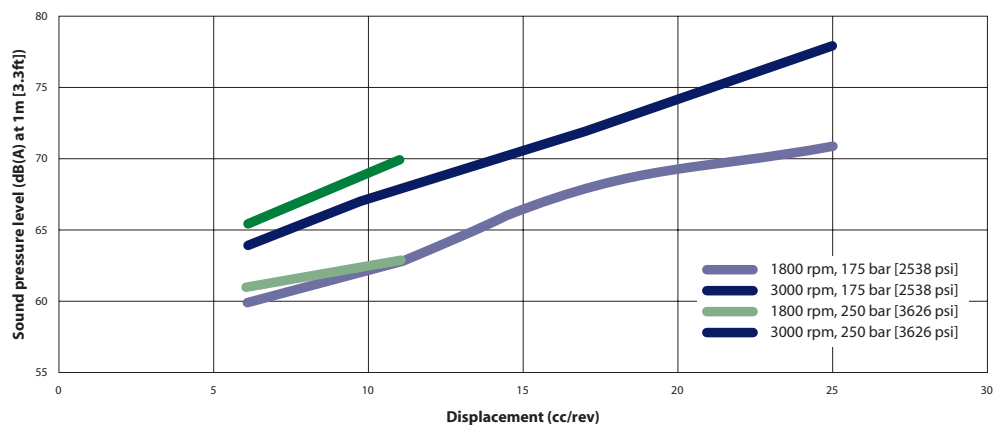

Performance graphs

The graphs on the next pages provide typical output flow and input power for Group 2 pumps at various working pressures. Data were taken using ISO VG46 petroleum /mineral based fluid at 50 °C (viscosity at 28 mm<sup>2</sup>/s [cSt]).

Performance graph for 4,0 frame size

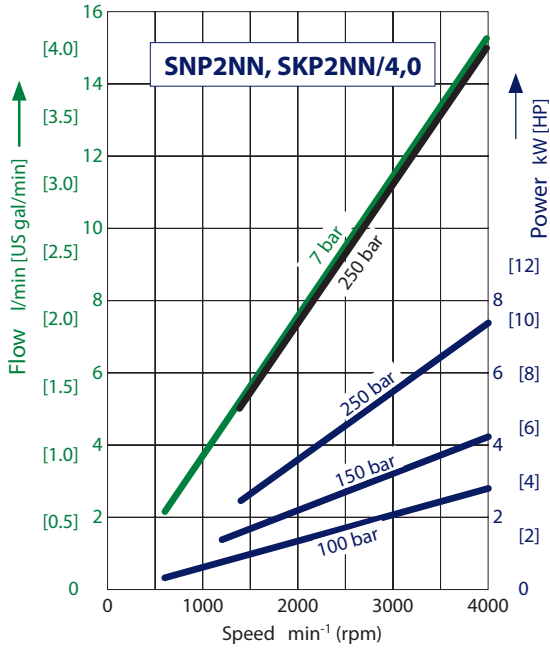

Performance graph for 6,0 frame size

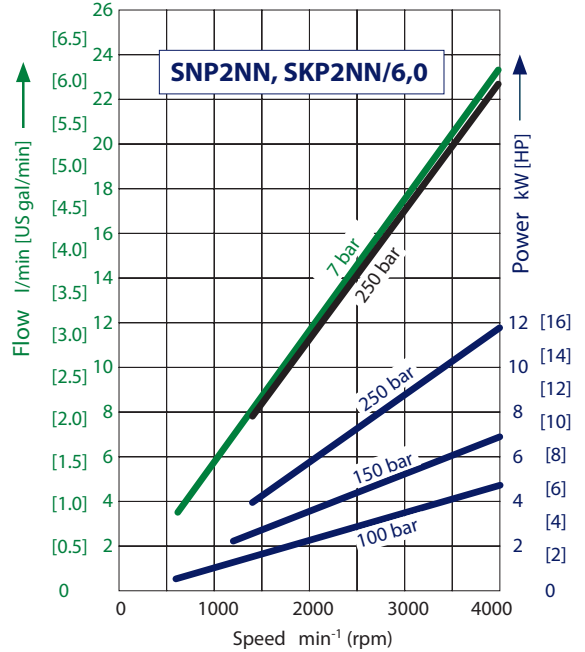

Performance graph for 8,0 frame size

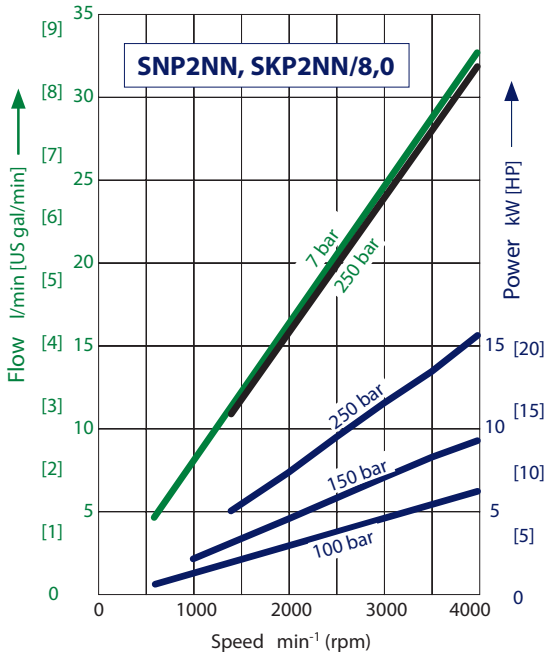

Performance graph for 011 frame size

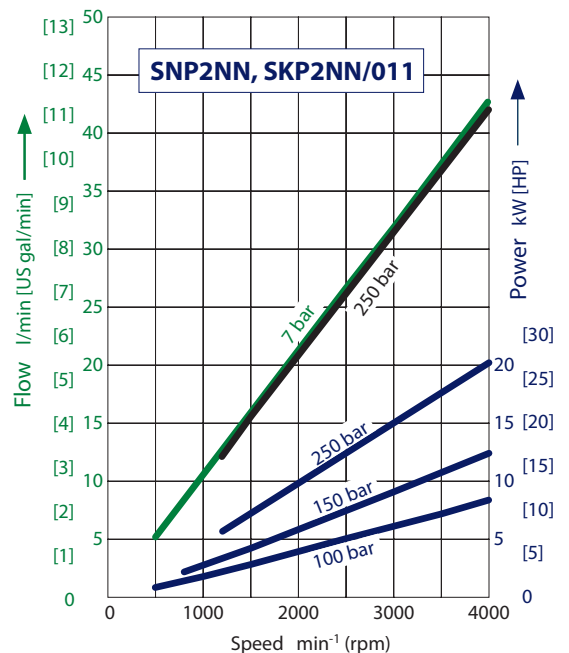

Performance graphs (continued)

Performance graph for 014 frame size

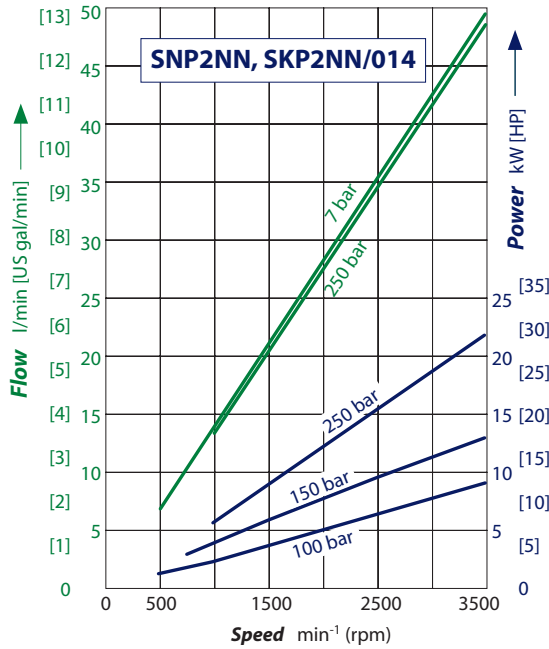

Performance graph for 017 frame size

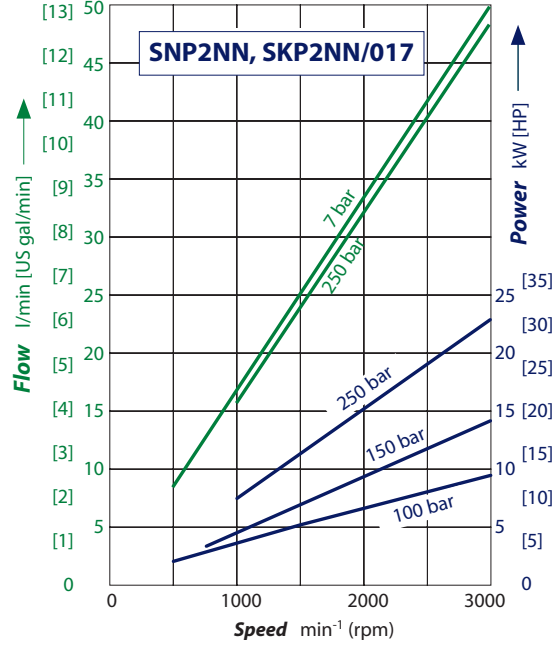

Performance graph for 019 frame size

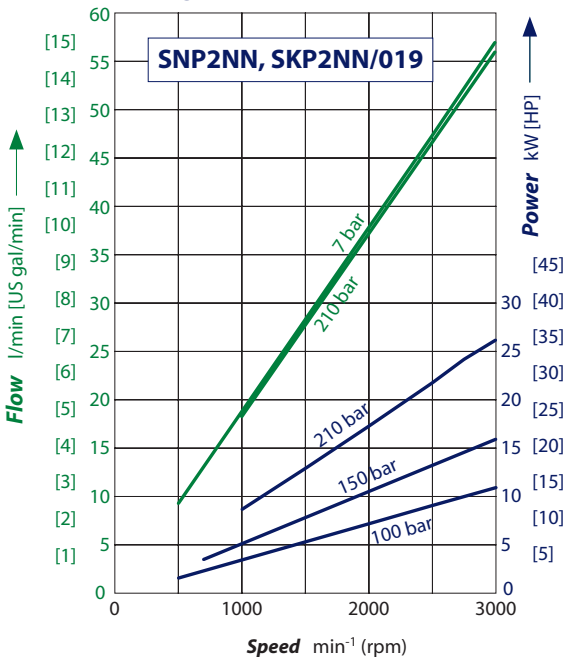

Performance graph for 022 frame size

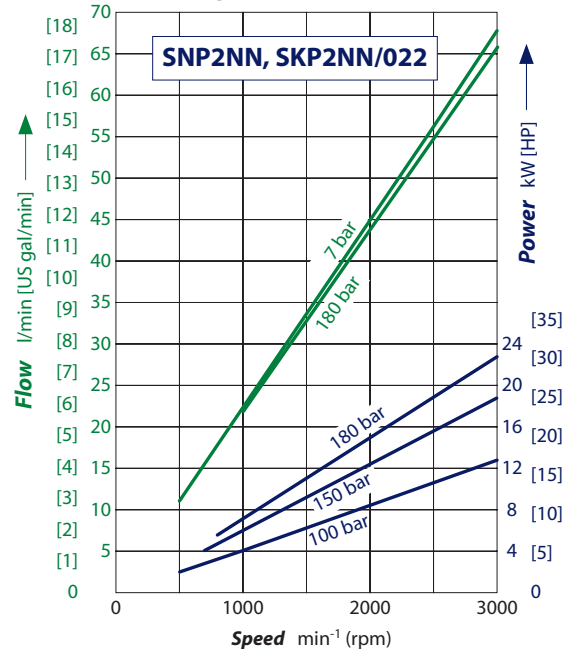

Performance graphs (continued)

Performance graph for 025 frame size

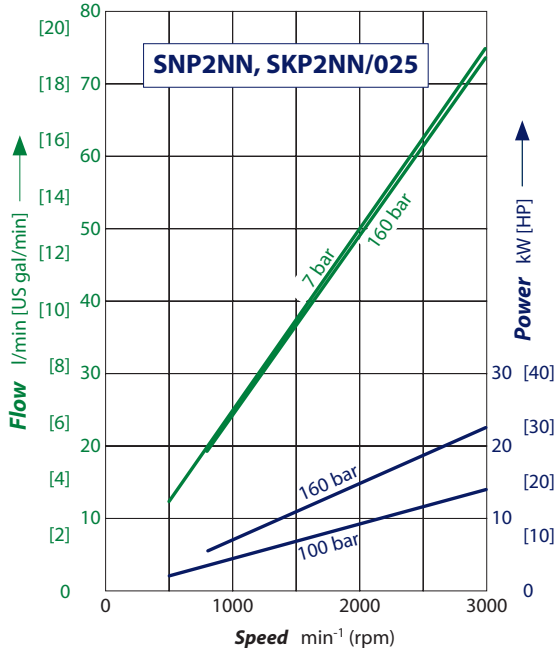

Performance graph for 019 frame size

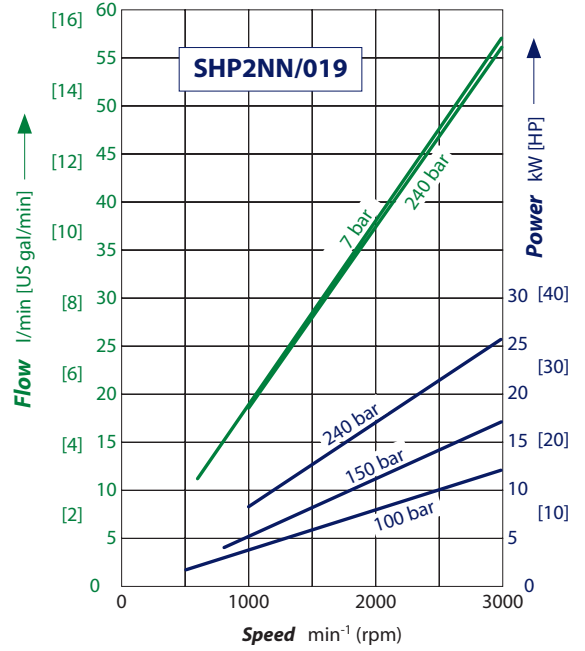

Performance graph for 022 frame size

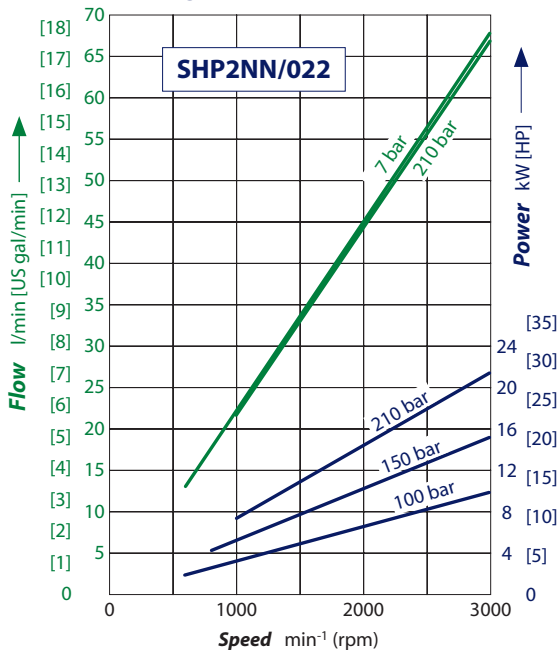



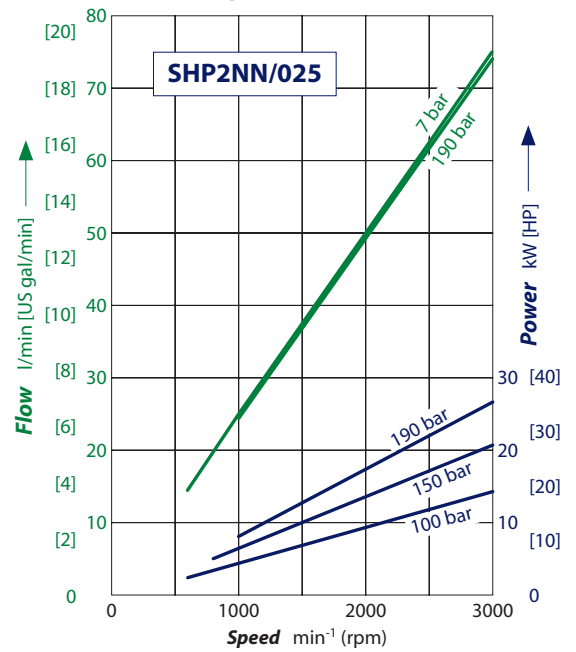

Performance graph for 025 frame size

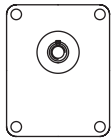
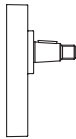
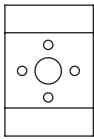
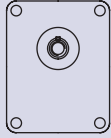
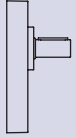
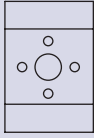
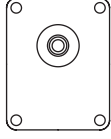
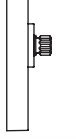
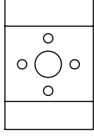
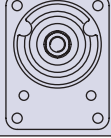
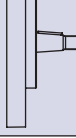
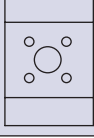
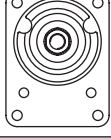
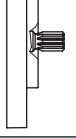
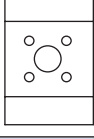
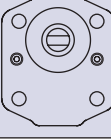
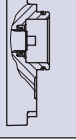
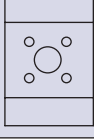

## Group 2 Gear Pumps Technical Information Product Options

### Flange, shaft and ports configurations

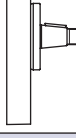
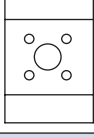
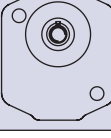
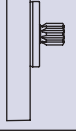
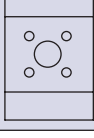
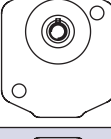
#### Available flange, shaft and ports configurations

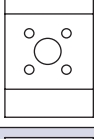
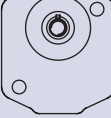
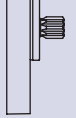
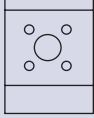
Code	Flange	Shaft	Ports
<b>01BA</b>	pilot Ø 36.5 mm [1.438 in] European 01, 4-bolt 	1:8 tapered 	European flanged, + pattern 
<b>01FA</b>	pilot Ø 36.5 mm [1.438 in] European 01, 4-bolt 	Ø 15 mm [0.59 in] parallel 	European flanged, + pattern 
<b>01DA</b>	pilot Ø 36.5 mm [1.438 in] European 01, 4-bolt 	Splined 9T - m 1.60 DIN 5482-B17x14 	European flanged, + pattern 
<b>02AA</b>	pilot Ø 80 mm [3.15 in] German PTO, 4-bolt 	1:5 tapered 	German std, X pattern 
<b>02DB</b>	pilot Ø 80 mm [3.15 in] German PTO, 4-bolt 	Splined 9T - m 1.60 DIN 5482-B17x14 	German std, X pattern 
<b>03CA</b>	Turolia OCG 03 	Turolia OCG tang 	German std, X pattern 
<b>04AA</b>	pilot Ø 50 mm [1.969 in] German PTO, 2-bolt 	1:5 tapered 	German std, X pattern 
<b>04DB</b>	pilot Ø 50 mm [1.969 in] German PTO, 2-bolt 	Splined 9T - m 1.60 DIN 5482-B17x14 	German std, X pattern 
<b>05AA</b>	pilot Ø 50 mm [1.969 in] German PTO, 2-bolt 	1:5 tapered 	German std, X pattern 
<b>05DB</b>	pilot Ø 50 mm [1.969 in] German PTO, 2-bolt 	Splined 9T - m 1.60 DIN 5482-B17x14 	German std, X pattern 

## Group 2 Gear Pumps Technical Information Product Options

### Flange, shaft and ports configurations (continued)

Flange, shaft and port configurations

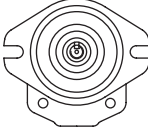
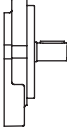
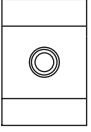
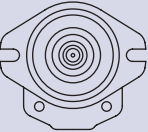
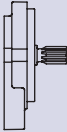
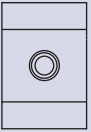
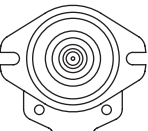
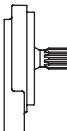
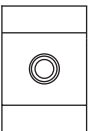
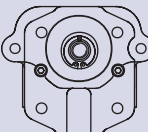
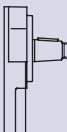
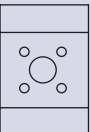
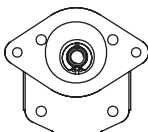
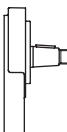
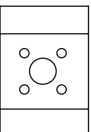
Code	Flange	Shaft	Port
<b>06GA</b>	pilot Ø 82.55 mm [3.25 in] SAE A, 2-bolt 	Ø 15.875 mm [0.625 in] parallel 	Threaded SAE O-Ring boss 
<b>06SA</b>	pilot Ø 82.55 mm [3.25 in] SAE A, 2-bolt 	9-teeth splined SAE spline J 498- 9T-16/32DP 	Threaded SAE O-Ring boss 
<b>06SB</b>	pilot Ø 82.55 mm [3.25 in] SAE A, 2-bolt 	11-teeth splined SAE spline J 498- 11T-16/32DP 	Threaded SAE O-Ring boss 
<b>09BJ</b>	pilot Ø 52.34 mm [2.061 in] Perkins 4.236 timing case 	1:8 tapered 	German std X pattern 
<b>A9BJ</b>	pilot Ø 52.34 mm [2.061 in] Perkins 900 series 	1:8 tapered 	German std X pattern 

## Group 2 Gear Pumps Technical Information Product Options

### Mounting flanges

Turolla OCG offers many types of industry standard mounting flanges. This table shows order codes for each available mounting flange and its intended use:

#### Flange availability



Flange	
Code	Description
01	European 36.5 mm 4-bolts
02	European 80 mm 4-bolts
03	Turolla OCG 03
06	Pilot Ø 82.55 mm [3.25 in] SAE A, 2-bolts
09	Pilot Ø 52.34 mm [2.061 in] Perkins 4.236 timing caret
A9	Pilot Ø 52.34 mm [2.061 in] Perkins 900 series

### Shaft options

Direction is viewed facing the shaft. Group 2 pumps are available with a variety of tang, splined, parallel, and tapered shaft ends. Not all shaft styles are available with all flange styles.

#### Shaft versus flange availability and torque capability



Shaft Description	Code	Mounting flange code with maximum torque in N·m [[lbf·in]							
		01	02	03	04	05	06	09	A9
Taper 1:5	AA	-	140 [1239]	-	140 [1239]	140 [1239]	-	-	-
Taper 1:8	BA	150 [1328]	-	-	-	-	-	150 [1328]	150 [1328]
DIN spline B17x14	DA	90 [797]	-	-	-	-	-	-	-
DIN spline B17x14	DB	-	130 [1151]	-	130 [1151]	130 [1151]	-	-	-
SAE spline 9T 16/32p	SA	-	-	-	-	-	75 [646]	-	-
SAE spline 11T 16/32p	SB	-	-	-	-	-	150 [1328]	-	-
Parallel 15 mm [0.590 in]	FA	90 [797]	-	-	-	-	-	-	-
Parallel 15.875 mm [0.625 in]	GA	-	-	-	-	-	80 [708]	-	-
Turolla OCG Tang	CA	-	-	70 [620]	-	-	-	-	-

Recommended mating splines for Group 2 splined output shafts should be in accordance with SAE J498 or DIN 5482. Turolla OCG external SAE splines are flat root side fit with circular tooth thickness reduced by 0.127 mm [0.005 in] in respect to class 1 fit. The external DIN splines have an offset increased by 0.1 mm [0.004 in.] These dimensions are modified in order to assure a clearance fit with the mating spline.

Other shaft options may exist. Contact your Turolla OCG representative for availability.

### ⚠ Caution

Shaft torque capability may limit allowable pressure. Torque ratings assume no external radial loading. Applied torque must not exceed these limits, regardless of stated pressure parameters. Maximum torque ratings are based on shaft torsional fatigue strength.



## Group 2 Gear Pumps Technical Information Product Options

### Inlet/Outlet port configurations

Various port configurations are available on Group 2 pumps. They include:

- European standard flanged ports
- German standard flanged ports
- Gas threaded ports (BSPP)
- O-Ring boss (following SAE J1926/1 [ISO 11926-1] UNF threads, standard)

**G** – Inlet port configuration codes and **H** – Outlet port configuration codes

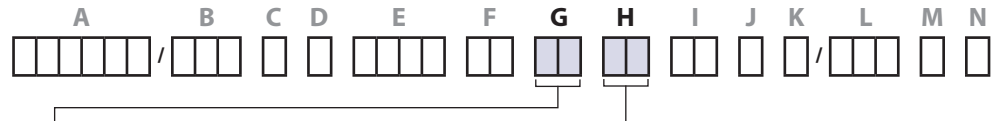

<b>B5</b>	15x35xM6	Flanged port 4 threaded holes in <b>X</b> pattern, in center or off-set of body
<b>B6</b>	15x40xM6	
<b>B7</b>	20x40xM6	
<b>BB</b>	27x55xM8	
<b>C2</b>	12x26xM5	Flanged port 4 threaded holes in <b>+</b> pattern (European standard ports)
<b>C3</b>	13,5x30xM6	
<b>C5</b>	13,5x40xM8	
<b>C7</b>	20x40xM8	
<b>C8</b>	23,5x40xM8	
<b>D4</b>	M16x1,5	Threaded metric port
<b>D5</b>	M18x1,5	
<b>D7</b>	M22x1,5	
<b>D9</b>	M26x1,5	
<b>E3</b>	1/16-18UNF	Threaded SAE O-Ring boss port
<b>E4</b>	3/4-16UNF	
<b>E5</b>	7/8-14UNF	
<b>E6</b>	1 1/16-12UN	
<b>E8</b>	1 5/16-12UN	
<b>F3</b>	3/8 GAS	Threaded GAS (BSPP) port
<b>F4</b>	1/2 GAS	
<b>F5</b>	3/4 GAS	
<b>F6</b>	1 GAS	
<b>H5</b>	M18x1,5	Threaded metric port ISO 6149
<b>H7</b>	M22x1,5	
<b>H8</b>	M27x2	
<b>H9</b>	M33x2	

## Group 2 Gear Pumps Technical Information Product Options

### Pumps with integral relief valve • SNP2EN and SNP2IN

Group 2 pumps are offered with an optional **integral relief valve** in the rear cover . This valve can have an internal (SNP2IN) or external (SNP2EN) drain. This valve opens directing all flow from the pump outlet to the internal or external drain when the pressure at the outlet reaches the valve setting. This valve can be ordered preset to the pressures shown in the table below. Valve performance curve, rear cover cross-section and schematics are shown below.

#### ⚠ Caution

When the relief valve is operating in bypass condition, rapid heat generation occurs. If this bypass condition continues, the pump prematurely fails. The reason for this is that it is a rule, not an exception. When frequent operation is required, external drain option (SNP2EN) must be used.

Valve performance graph

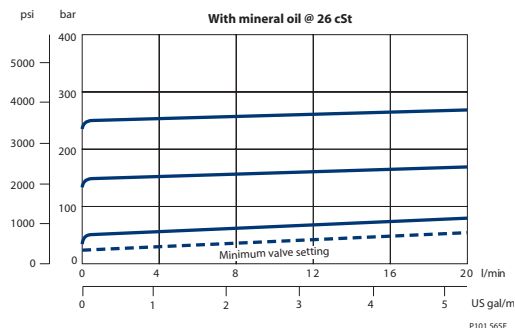

Integral relief valve cross-section

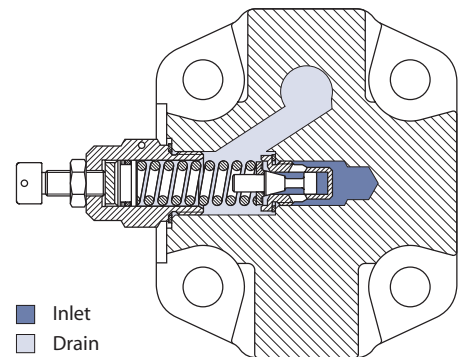

### Integral relief valve schematics

Integral relief valve schematic (internal drain)

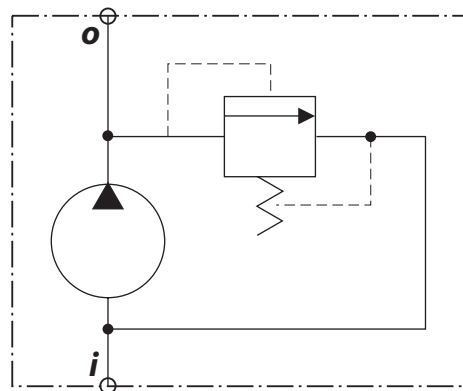

Integral relief valve schematic (external drain)

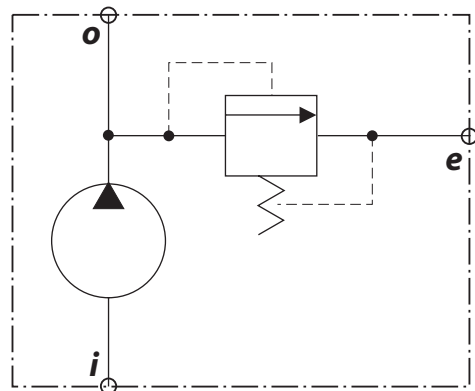

Where:  
*i* = inlet  
*o* = outlet  
*e* = external drain

**Pumps with integral relief valve • SNP2EN and SNP2IN (continued)**

**Variant codes for ordering integral relief valves**

The tables below detail the various codes for ordering integral relief valves in **L** section of model code.

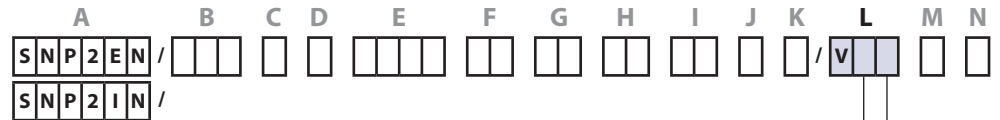

Code	Pump speed for RV setting
A	Not defined
C	500 min <sup>-1</sup> (rpm)
E	1000 min <sup>-1</sup> (rpm)
F	1250 min <sup>-1</sup> (rpm)
G	1500 min <sup>-1</sup> (rpm)
K	2000 min <sup>-1</sup> (rpm)
I	2250 min <sup>-1</sup> (rpm)
L	2500 min <sup>-1</sup> (rpm)
M	2800 min <sup>-1</sup> (rpm)
N	3000 min <sup>-1</sup> (rpm)
O	3250 min <sup>-1</sup> (rpm)

Code	Pressure setting
A	No setting
B	No valve
C	18 bar [261 psi]
D	25 bar [363 psi]
E	30 bar [435 psi]
F	35 bar [508 psi]
G	40 bar [580 psi]
K	50 bar [725 psi]
L	60 bar [870 psi]
M	70 bar [1015 psi]
N	80 bar [1160 psi]
O	90 bar [1305 psi]
P	100 bar [1450 psi]
Q	110 bar [1595 psi]
R	120 bar [1740 psi]
S	130 bar [1885 psi]
T	140 bar [2030 psi]
U	160 bar [2320 psi]
V	170 bar [2465 psi]
W	180 bar [2611 psi]
X	210 bar [3046 psi]
Y	240 bar [3480 psi]
Z	250 bar [3626 psi]

For pressures higher than 210 bar [3046 psi] and lower than 40 bar [580 psi] apply to your Turolia OCG representative.

Group 2 Gear Pumps  
Technical Information  
Product Options

Pumps with integral relief valve • **SNP2EN** and **SNP2IN** (continued)

Integral relief valve covers **SNP2IN**

Dimensions

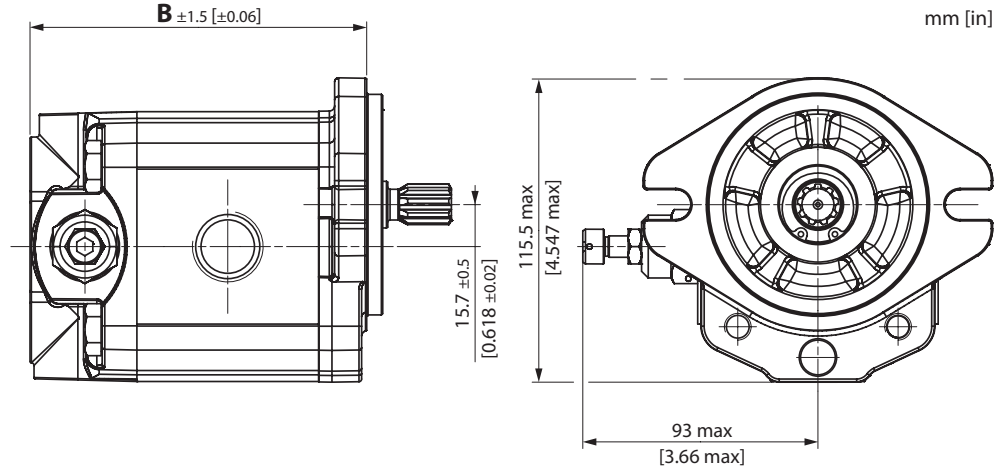

Dimensions of integral relief valve cover with SAE flange

Type	4,0	6,0	8,0	011	014	017	019	022	025
<b>B</b>	110.0	113.5	117.5	121.5	127.5	131.5	135.5	141.5	145.5
<b>mm [in]</b>	[4.33]	[4.47]	[4.63]	[4.78]	[5.02]	[5.18]	[5.33]	[5.57]	[5.73]

## Group 2 Gear Pumps Technical Information Product Options

### Outrigger bearing assembly

An outrigger bearing is available for applications with high radial or thrust loads on the shaft. This option is used primarily for applications with high shaft loads such as to belt or chain drives. The design utilizes roller bearings in the front mounting flange. These bearings absorb the radial and thrust loads on the shaft so that the life of the pump is not affected. The use of roller bearings allows life to be described in  $B_{10}$  hours.

### Available configurations

Codes **A9DB**, **9FDB**, **94DB**, **9HDB** and **9JDB** represent assembly (pump complete with outrigger bearing).



Code	Shaft	Mounting flange
<b>A9DB</b>	Taper 1:8	European 4-bolts
<b>9FDB</b>	Taper 1:5	German PTO
<b>94DB</b>	Taper 1:5	German 4-bolts
<b>9HDB</b>	Taper 1:8	SAE A
<b>9JDB</b>	Parallel	SAE A

Outrigger bearings  
assembly (continued)

Dimensions

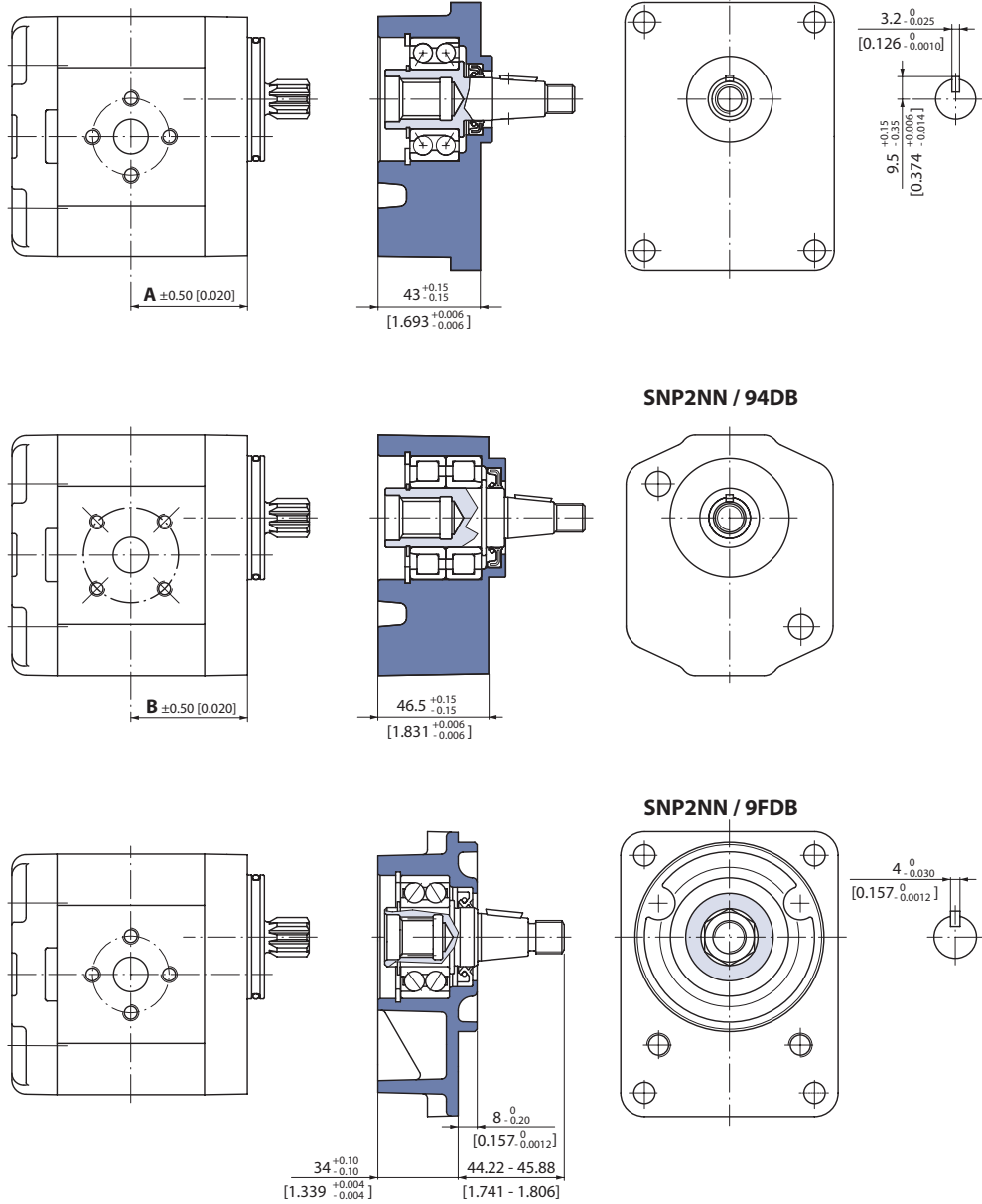

Outrigger bearings  
assembly (continued)

Dimensions

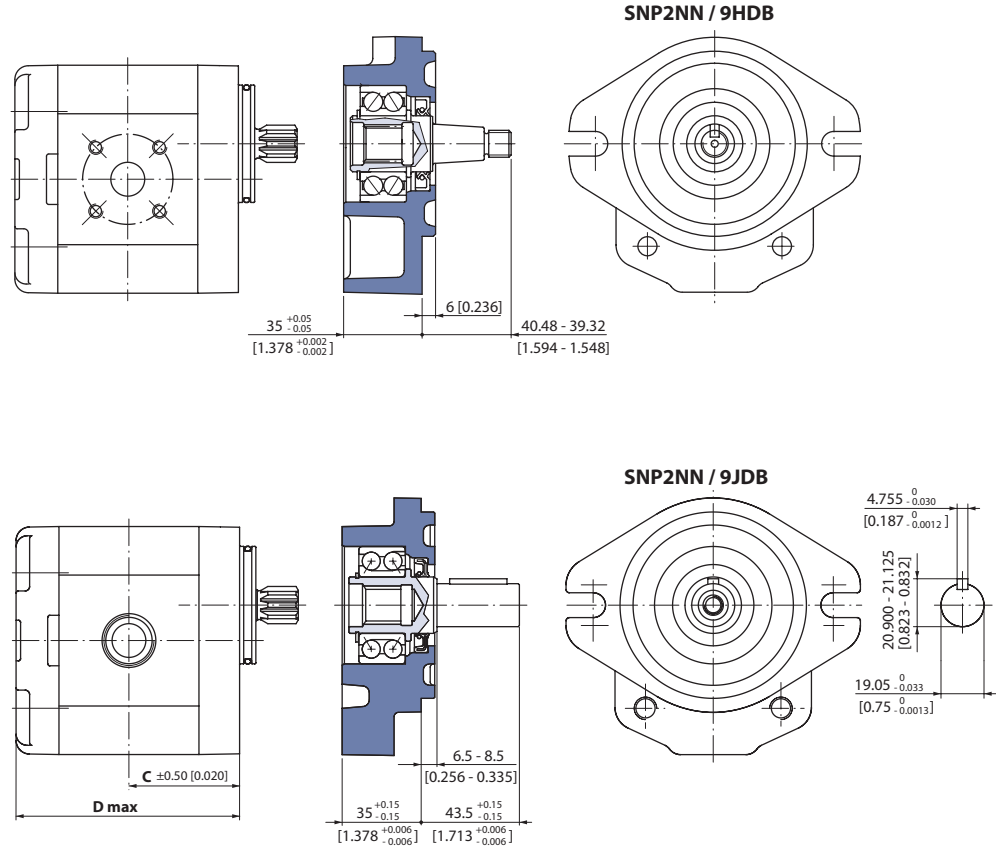

Dimensions

Type vs. Dimension	4,0	6,0	8,0	011	014	017	019	022	025
<b>A</b>	43.25 [1.703]	45 [1.772]	45 [1.772]	49 [1.929]	52 [2.047]	52 [2.047]	56 [2.205]	59 [2.323]	59 [2.323]
<b>B</b>	37.3 [1.469]	38.6 [1.520]	40.6 [1.598]	45 [1.772]	45 [1.772]	45 [1.772]	45 [1.772]	52.5 [2.067]	62 [2.441]
<b>C</b>	43.25 [1.703]	45 [1.772]	47 [1.850]	49 [1.929]	52 [2.047]	54 [2.126]	56 [2.205]	59 [2.323]	61 [2.402]
<b>D</b>	90 [3.543]	93.5 [3.681]	97.5 [3.839]	101.5 [3.996]	107.5 [4.232]	111.5 [4.390]	115.5 [4.574]	121.5 [4.783]	125.5 [4.941]

## Group 2 Gear Pumps Technical Information Product Options

### Auxiliary mounting pads

SAE A auxiliary mounting pads are available for all Group 2 pumps with SAE A front flange and coupling 9 teeth 16/32 pitch. These pads are used for mounting auxiliary hydraulic pumps or creating special tandem gear pumps.

To order pumps with SAE A auxiliary mounting flange:

- Specify **06SL** in field **E** of the model code as shown below
- Order the auxiliary mounting pad kit, part number 818.20.079.0K



Since the drive coupling is lubricated with oil from the main pump inlet, an O-ring must be used to seal the auxiliary pump-mounting flange to the pad.

- The combination of auxiliary mounting pad shaft torque, plus the main pump torque should not exceed the maximum pump input shaft rating 75 N•m [664 lbf•in].
- All torque values assume a 58 HRC shaft spline hardness on mating pump shaft.

*Outline drawing with the dimensions of the auxiliary pump mounting flange and shaft.*

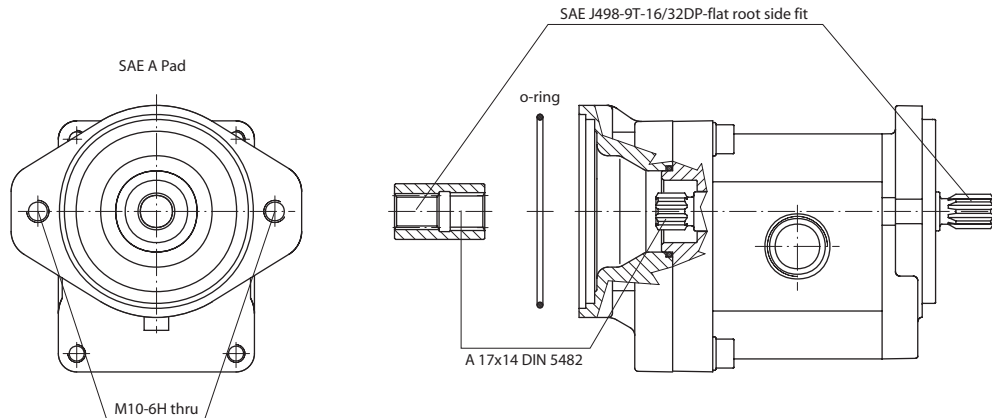



Auxiliary mounting pads (continued)

Dimensions for SNP2NN / 06SL flange/shaft option with auxiliary mounting pad kit installed

mm [in]

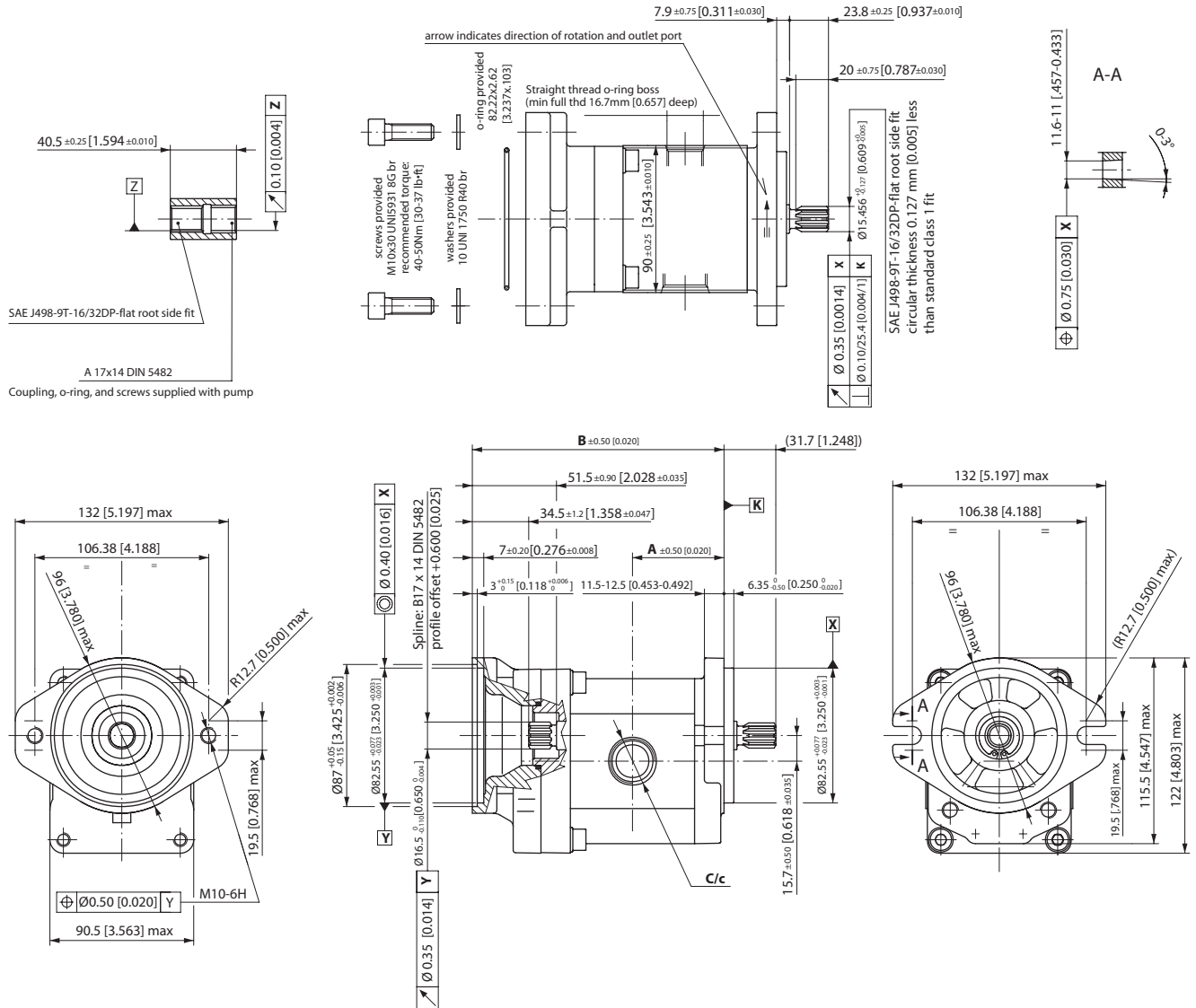

Dimensions

Type (displacement)	4,0	6,0	8,0	011	014	017	019	022	025
<b>A</b>	43.25 [1.703]	45.0 [1.772]	47.0 [1.850]	49.0 [1.929]	52.0 [2.047]	54.0 [2.126]	56.0 [2.205]	59.0 [2.323]	61.0 [2.402]
<b>B</b>	128.5 [5.059]	132 [5.197]	136 [5.354]	140 [5.512]	146 [5.748]	150 [5.906]	154 [6.063]	160 [6.299]	164 [6.457]
<b>Inlet C</b>	1.063 (1 1/16) 12UN - 2B; 18 mm [0.709 in] deep								
<b>Outlet c</b>	0.875 (7/8) - 14UNF - 2B; 16.7 mm [0.658 in] deep								

Pump ports

Available pump ports

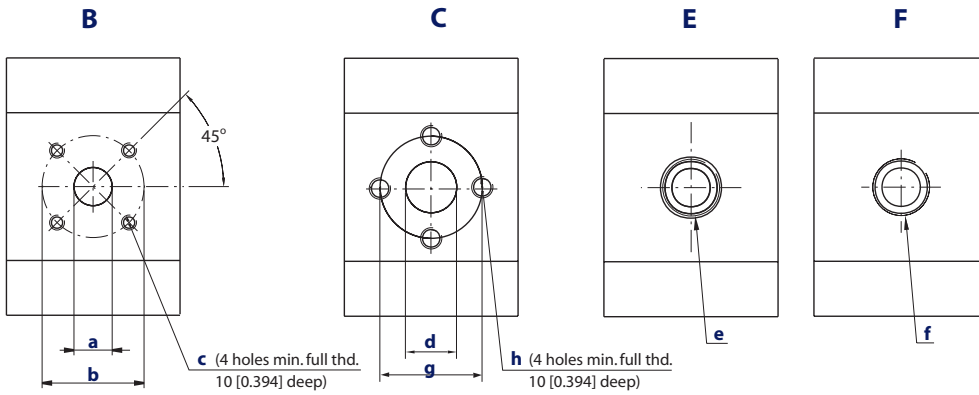

Dimensions of pumps ports

Port type		B			C			E	F	
Port dimensions		a	b	c	d	g	h	e	f	
Frame size	4,0	Inlet	15 [0.591]	40 [1.575]	M6	13.5 [0.531]	30 [1.181]	M6	1 1/16-12UNF-2B	1/2 Gas (BSPP)
		Outlet	15 [0.591]	35 [1.378]	M6	13.5 [0.531]	30 [1.181]	M6	7/8-14UNF-2B	1/2 Gas (BSPP)
	6,0	Inlet	15 [0.591]	40 [1.575]	M6	13.5 [0.531]	30 [1.181]	M6	1 1/16-12UNF-2B	1/2 Gas (BSPP)
		Outlet	15 [0.591]	35 [1.378]	M6	13.5 [0.531]	30 [1.181]	M6	7/8-14UNF-2B	1/2 Gas (BSPP)
	8,0	Inlet	20 [0.787]	40 [1.575]	M6	13.5 [0.531]	30 [1.181]	M6	1 1/16-12UNF-2B	1/2 Gas (BSPP)
		Outlet	15 [0.591]	35 [1.378]	M6	13.5 [0.531]	30 [1.181]	M6	7/8-14UNF-2B	1/2 Gas (BSPP)
	011	Inlet	20 [0.787]	40 [1.575]	M6	13.5 [0.531]	30 [1.181]	M6	1 1/16-12UNF-2B	3/4 Gas (BSPP)
		Outlet	15 [0.591]	35 [1.378]	M6	13.5 [0.531]	30 [1.181]	M6	7/8-14UNF-2B	1/2 Gas (BSPP)
	014	Inlet	20 [0.787]	40 [1.575]	M6	20.0 [0.787]	40 [1.575]	M8	1 1/16-12UNF-2B	3/4 Gas (BSPP)
		Outlet	15 [0.591]	35 [1.378]	M6	13.5 [0.531]	30 [1.181]	M6	7/8-14UNF-2B	1/2 Gas (BSPP)
	017	Inlet	20 [0.787]	40 [1.575]	M6	20.0 [0.787]	40 [1.575]	M8	1 1/16-12UNF-2B	3/4 Gas (BSPP)
		Outlet	15 [0.591]	35 [1.378]	M6	13.5 [0.531]	30 [1.181]	M6	7/8-14UNF-2B	1/2 Gas (BSPP)
	019	Inlet	20 [0.787]	40 [1.575]	M6	20.0 [0.787]	40 [1.575]	M8	1 1/16-12UNF-2B	3/4 Gas (BSPP)
		Outlet	15 [0.591]	35 [1.378]	M6	13.5 [0.531]	30 [1.181]	M6	7/8-14UNF-2B	1/2 Gas (BSPP)
	022	Inlet	20 [0.787]	40 [1.575]	M6	20.0 [0.787]	40 [1.575]	M8	1 1/16-12UNF-2B	3/4 Gas (BSPP)
		Outlet	15 [0.591]	35 [1.378]	M6	13.5 [0.531]	30 [1.181]	M6	7/8-14UNF-2B	1/2 Gas (BSPP)
025	Inlet	20 [0.787]	40 [1.575]	M6	23.5 [0.925]	40 [1.575]	M8	1 1/16-12UNF-2B	1 Gas (BSPP)	
	Outlet	15 [0.591]	35 [1.378]	M6	20.0 [0.787]	40 [1.575]	M8	7/8-14UNF-2B	3/4 Gas (BSPP)	



SNP2NN – 02DB and 02AA

Standard porting for 02DB and 02AA

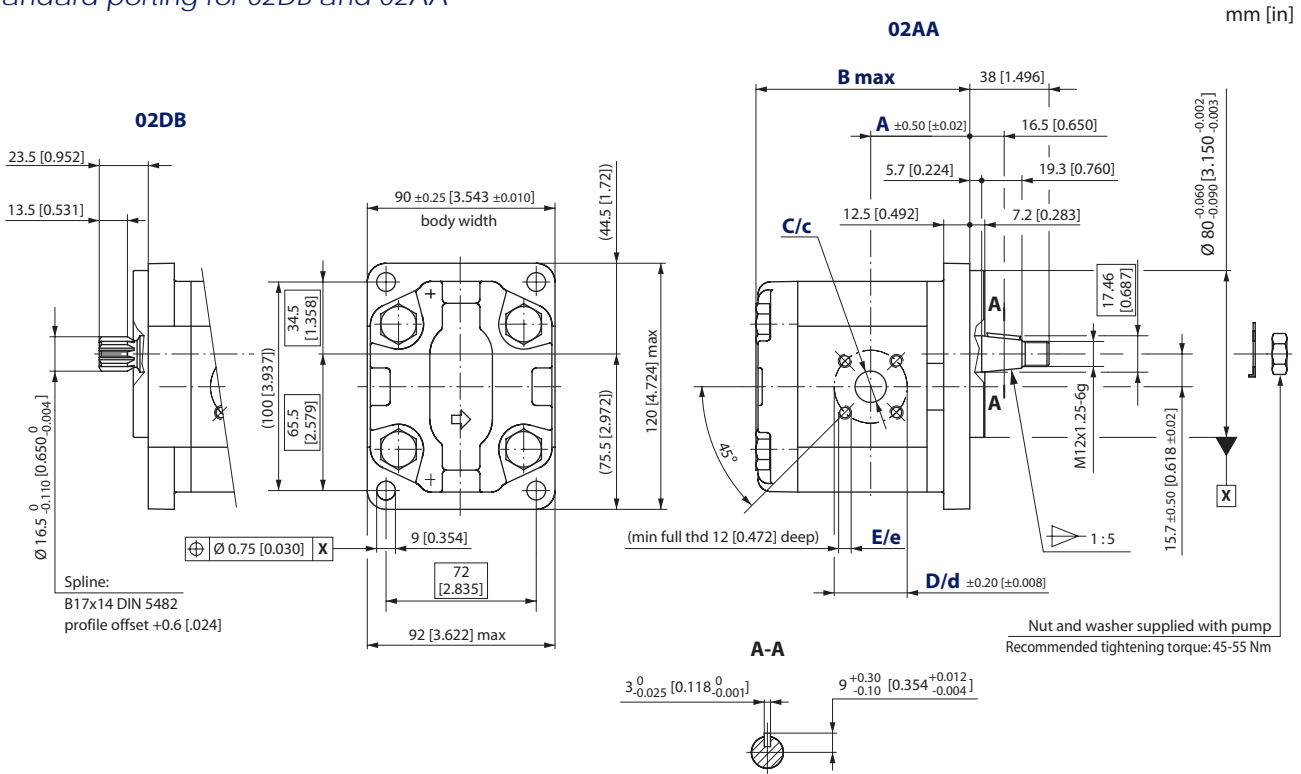

SNP2NN – 02DB and 02AA dimensions

Frame size		4,0	6,0	8,0	011	014	017	019	022	025
Dimension	A	39.8 [1.567]	41.1 [1.618]	43.1 [1.697]	47.5 [1.870]	47.5 [1.870]	47.5 [1.870]	47.5 [1.870]	55 [2.165]	64.5 [2.539]
	B	92.5 [3.642]	96 [3.780]	100 [3.937]	104 [4.094]	110 [4.331]	114 [4.488]	118 [4.646]	124 [4.882]	128 [5.039]
Inlet	C	15 [0.591]	15 [0.591]	20 [0.787]	20 [0.787]	20 [0.787]	20 [0.787]	20 [0.787]	20 [0.787]	20 [0.787]
	D	40 [1.575]								
	E	M6								
Outlet	c	15 [0.591]								
	d	35 [1.378]								
	e	M6								

Model code examples and maximum shaft torque

Flange/drive gear	Model code example	Maximum shaft torque
02DB	SNP2NN/017LN02DBP1B7B5NNNN/NNNNN	130 N•m [1151 lbf•in]
02AA	SNP2NN/6,0RN02AAP1B6B5NNNN/NNNNN	140 N•m [1239 lbf•in]

For further details on ordering, see *Model Code*, pages 8÷9.

**SNP2NN – 03CA**

Standard porting for 03CA

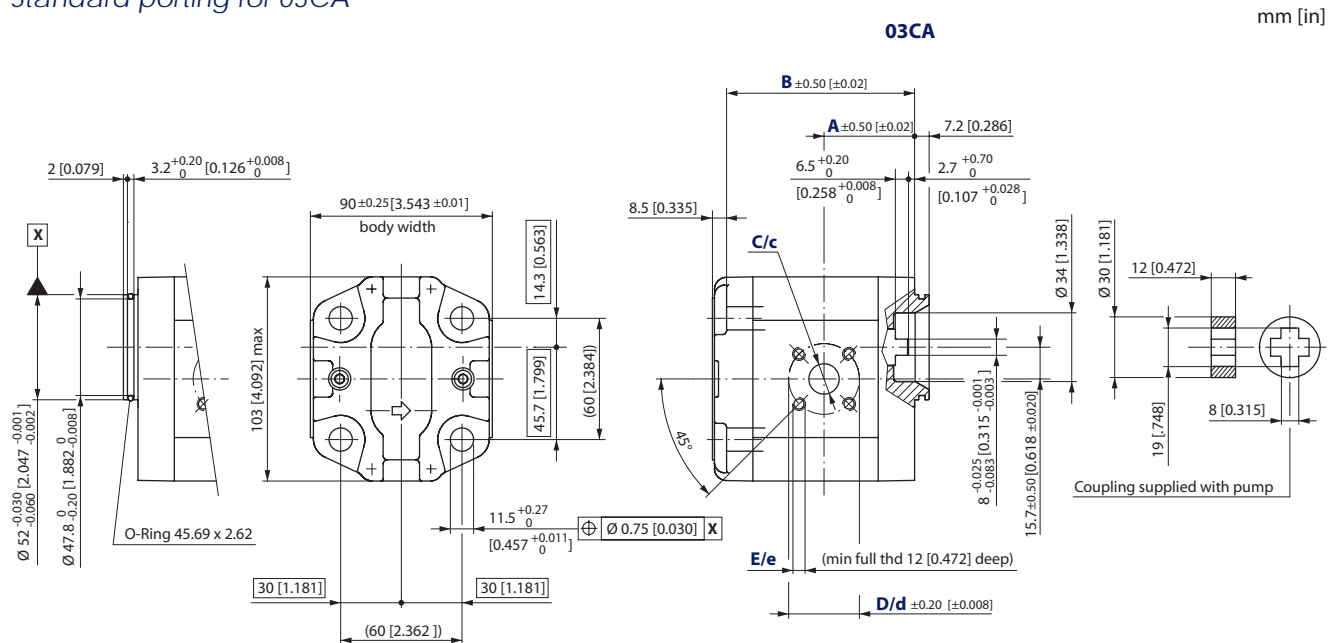

*SNP2NN – 03CA dimensions*

Frame size		4,0	6,0	8,0	011	014	017	019	022	025
Dimension	<b>A</b>	37.3 [1.469]	38.6 [1.520]	40.6 [1.598]	45 [1.772]	45 [1.772]	45 [1.772]	45 [1.772]	52.5 [2.067]	62 [2.441]
	<b>B</b>	81.5 [3.209]	85 [3.346]	89 [3.504]	93 [3.661]	99 [3.897]	103 [4.055]	107 [4.212]	113 [4.448]	117 [4.606]
Inlet	<b>C</b>	15 [0.591]	15 [0.591]	20 [0.787]	20 [0.787]	20 [0.787]	20 [0.787]	20 [0.787]	20 [0.787]	20 [0.787]
	<b>D</b>	40 [1.575]								
	<b>E</b>	M6								
Outlet	<b>c</b>	15 [0.591]								
	<b>d</b>	35 [1.378]								
	<b>e</b>	M6								

*Model code example and maximum shaft torque*

Flange/drive gear	Model code example	Maximum shaft torque
<b>03CA</b>	SNP2NN/014RN03CAP3B7B5NNNN/NNNN	70 N·m [620 lbf·in]

For further details on ordering, see *Model Code*, pages 8÷9.

### SNP2NN – 04/05DB and 04/05AA

Standard porting for 04/05DB and 04/05AA

mm [in]

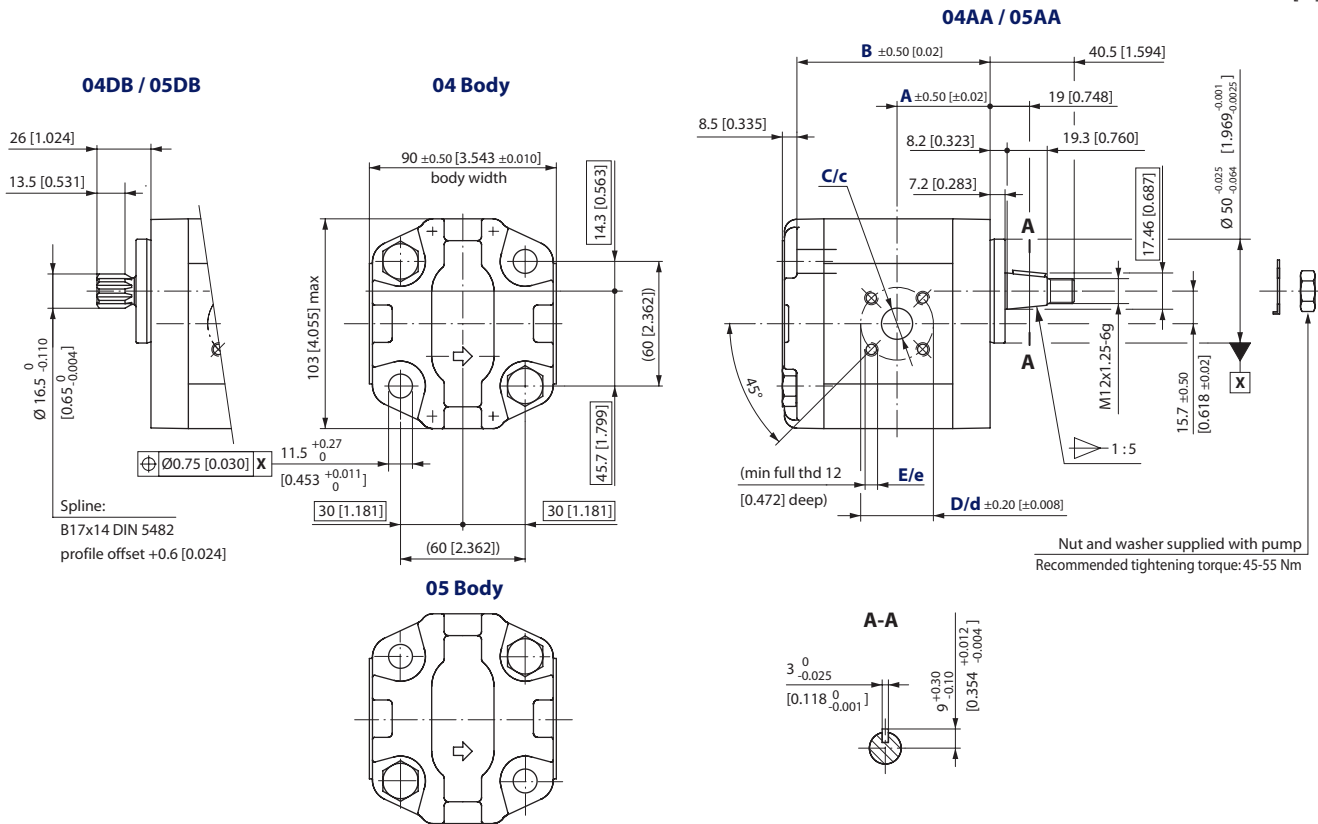

### SNP2NN – 04/05DB and 04/05AA dimensions

Frame size		4,0	6,0	8,0	011	014	017	019	022	025
Dimension	<b>A</b>	37.3 [1.469]	38.6 [1.520]	40.6 [1.598]	45 [1.772]	45 [1.772]	45 [1.772]	45 [1.772]	52.5 [2.067]	62 [2.441]
	<b>B</b>	81.5 [3.208]	85 [3.364]	89 [3.503]	93 [3.661]	99 [3.897]	103 [4.055]	107 [4.212]	113 [4.448]	117 [4.606]
Inlet	<b>C</b>	15 [0.591]	15 [0.591]	20 [0.787]	20 [0.787]	20 [0.787]	20 [0.787]	20 [0.787]	20 [0.787]	20 [0.787]
	<b>D</b>	40 [1.575]								
	<b>E</b>	M6								
Outlet	<b>c</b>	15 [0.591]								
	<b>d</b>	35 [1.378]								
	<b>e</b>	M6								

### Model code examples and maximum shaft torque

Flange/drive gear	Model code example	Maximum shaft torque
<b>04DB</b>	SNP2NN/8,0LN04DBP1B7B5NNNN/NNNNN	130 N•m [1151 lbf•in]
<b>05DB</b>	SNP2NN/022RN05DBP1B7B5NNNN/NNNNN	
<b>04AA</b>	SNP2NN/6,0LN04AAP1B6B5NNNN/NNNNN	140 N•m [1239 lbf•in]
<b>05AA</b>	SNP2NN/014RN05AAP1B7B5NNNN/NNNNN	

For further details on ordering, see *Model Code*, pages 8÷9.

### SKP2NN – 06SB and SNP2NN – 06SA, 06GA

Standard porting for 06SB (SKP2NN), and 06SA, 06GA (SNP2NN)

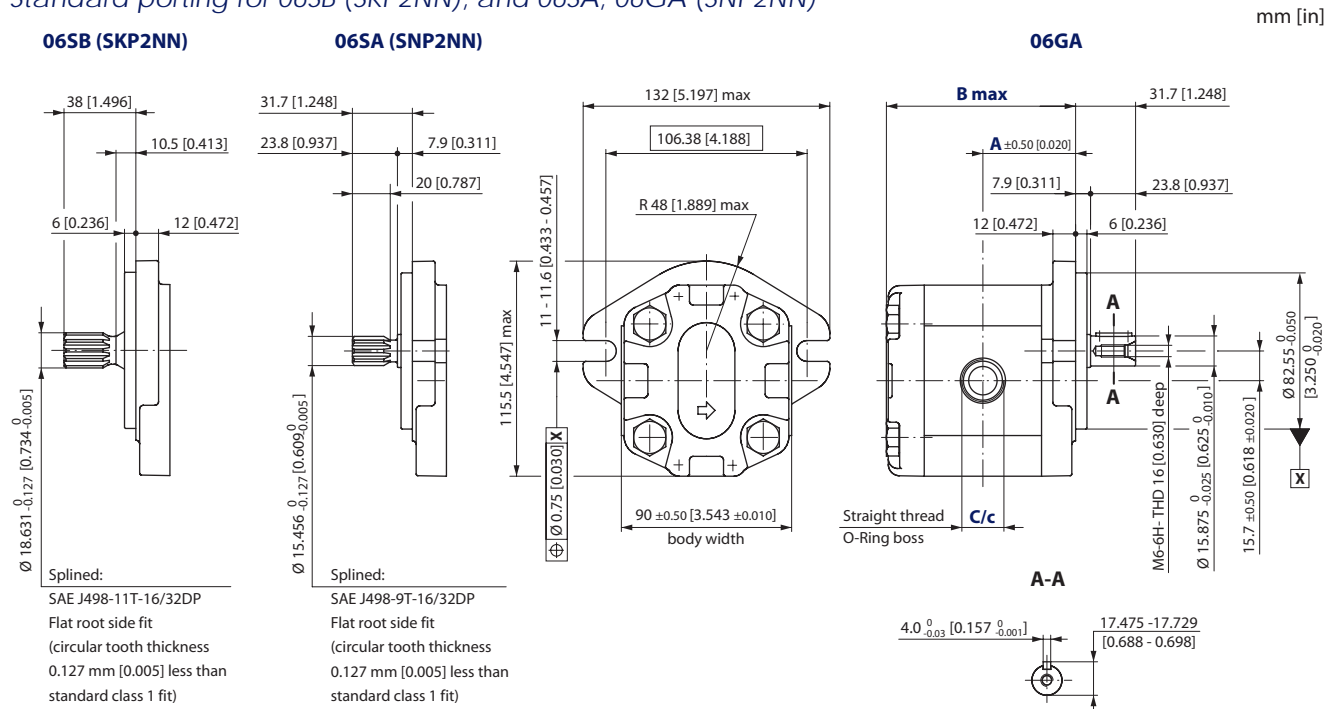

### SNP2NN – 06SA, 06GA and SKP2NN – 06SB dimensions

Frame size		4,0	6,0	8,0	011	014	017	019	022	025
Dimension	A	43.25 [1.703]	45 [1.772]	47 [1.850]	49 [1.920]	52 [2.047]	54 [2.205]	56 [2.205]	59 [2.323]	61 [2.402]
	B	90 [3.543]	93.5 [3.681]	97.5 [3.839]	101.5 [3.996]	107.5 [4.232]	111.5 [4.390]	115.5 [4.547]	121.5 [4.783]	125.5 [4.941]
Inlet	C	1 $\frac{1}{16}$ -12UNF-2B, 18.0 [0.709] deep								
Outlet	c	$\frac{7}{8}$ -14UNF-2B, 16.7 [0.658] deep								

### Model code examples and maximum shaft torque

Flange/drive gear	Model code example	Maximum shaft torque
06GA	SNP2NN/6,0RN06GAP1E6E5NNNN/NNNNN	80 N•m [708 lbf•in]
06SA (SNP2NN)	SNP2NN/011LN06SAP1E6E5NNNN/NNNNN	75 N•m [664 lbf•in]
06SB (SKP2NN)	SKP2NN/022RN06SBP1E6E5NNNN/NNNNN	150 N•m [1328 lbf•in]

For further details on ordering, see *Model Code*, pages 8÷9.





**SNP2NN – 09BJ**

Standard porting for 09BJ

**09BJ**

mm [in]

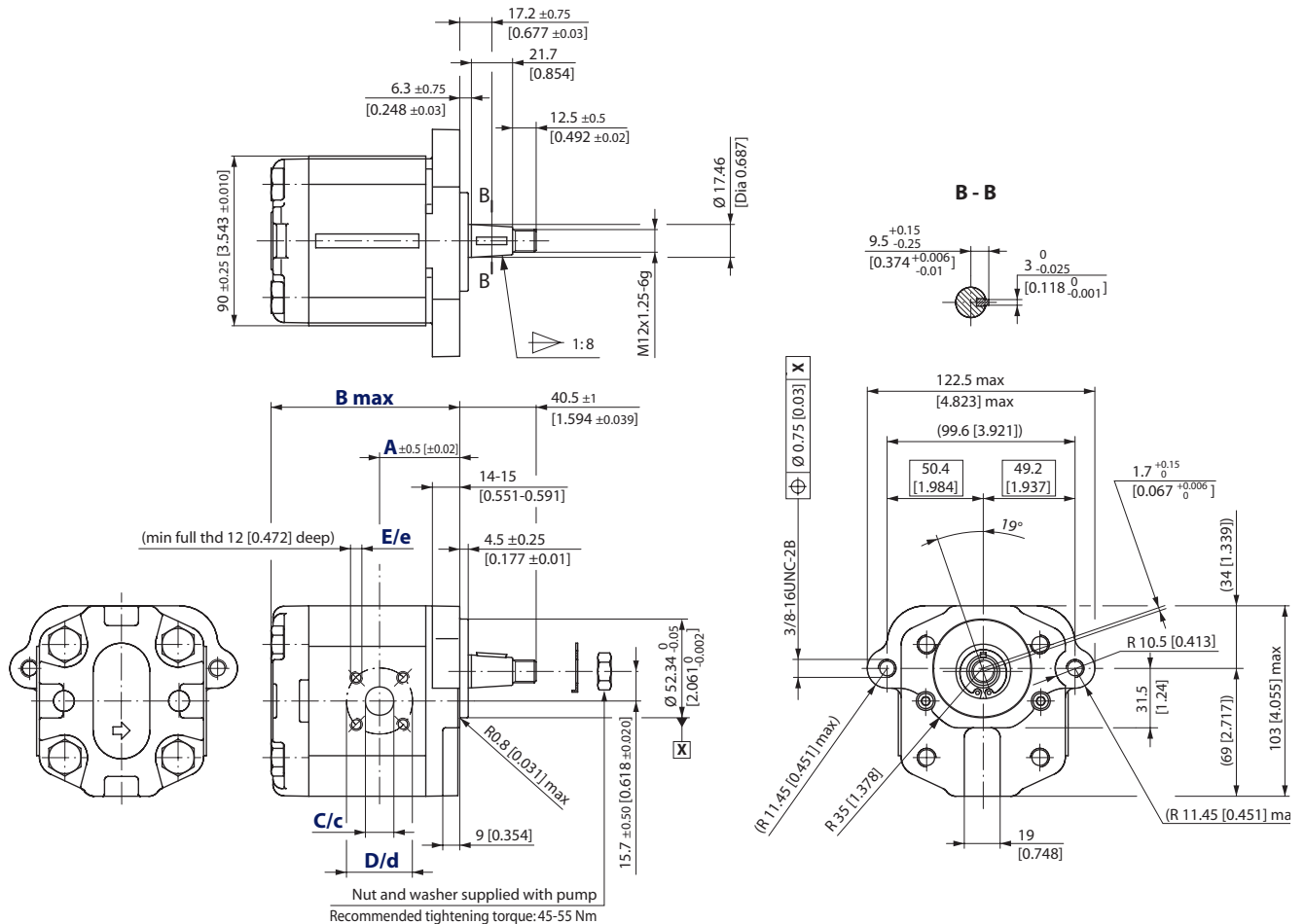

*SNP2NN – 09BJ dimensions*

Frame size		4,0	6,0	8,0	011	014	017	019	022	025
Dimension	<b>A</b>	37.3 [1.469]	38.6 [1.520]	40.6 [1.598]	45.0 [1.772]	45.0 [1.772]	45.0 [1.772]	45.0 [1.772]	52.5 [2.067]	62 [2.441]
	<b>B</b>	90 [3.543]	93.5 [3.681]	97.5 [3.839]	101.5 [3.996]	107.5 [4.232]	111.5 [4.390]	115.5 [4.547]	121.5 [4.783]	125.5 [4.941]
Inlet	<b>C</b>	15 [0.591]	15 [0.591]	20 [0.787]	20 [0.787]	20 [0.787]	20 [0.787]	20 [0.787]	20 [0.787]	20 [0.787]
	<b>D</b>	40 [1.575]								
	<b>E</b>	M6								
Outlet	<b>c</b>	15 [0.591]								
	<b>d</b>	35 [1.378]								
	<b>e</b>	M6								

*Model code example and maximum shaft torque*

Flange/drive gear	Model code example	Maximum shaft torque
<b>09BJ</b>	SNP2NN/014LN09BJP1B7B5NNNN/NNNN	150 N•m [1328 lbf•in]

For further details on ordering, see *Model Code*, pages 8÷9.

#### SNP2NN – A9BJ

Standard porting for A9BJ

mm [in]

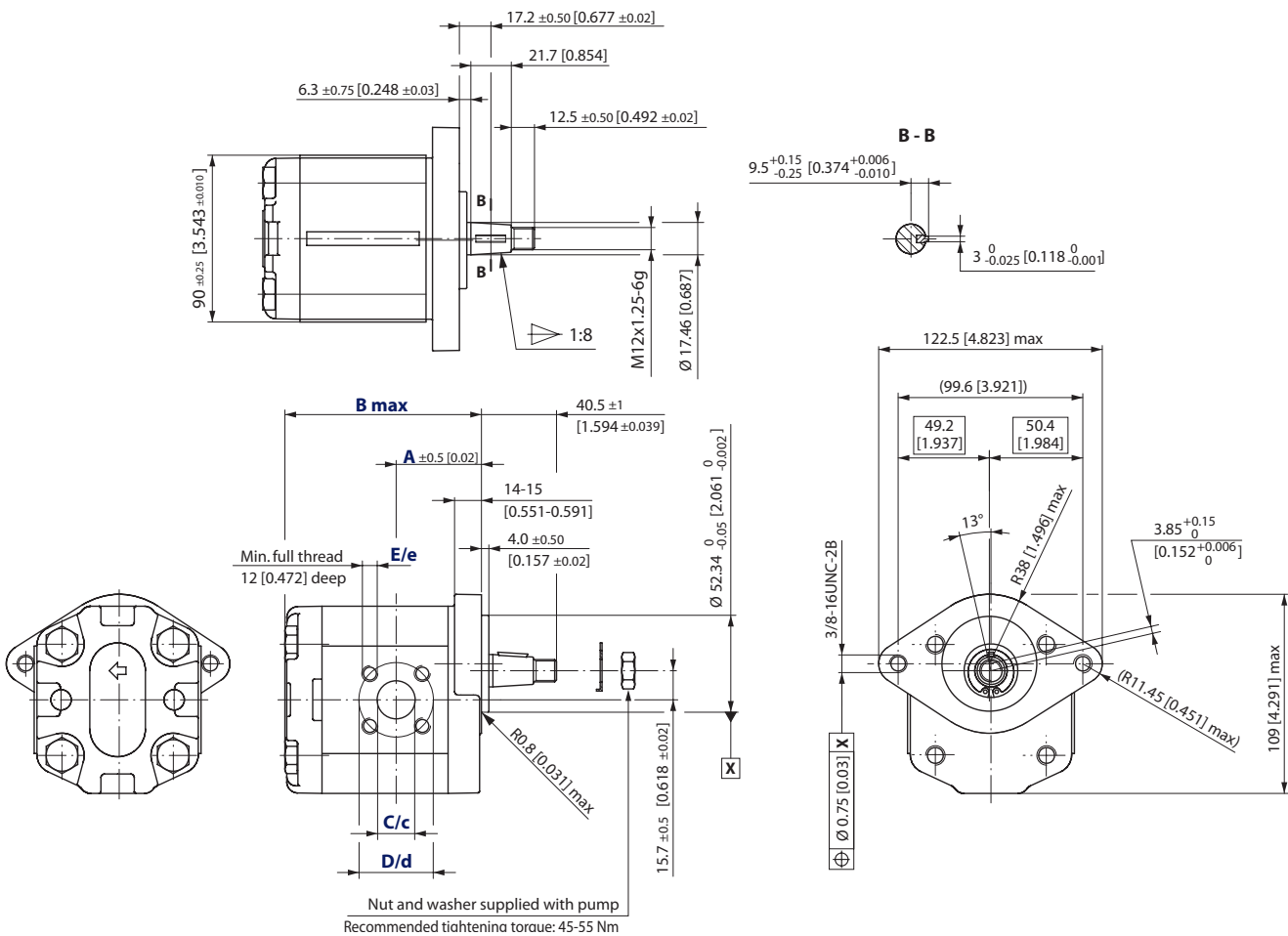

#### SNP2NN – A9BJ dimensions

Frame size		4,0	6,0	8,0	011	014	017	019	022	025
Dimension	A	37.3 [1.469]	38.6 [1.520]	40.6 [1.598]	45.0 [1.772]	45.0 [1.772]	45.0 [1.772]	45.0 [1.772]	52.5 [2.067]	62 [2.441]
	B	90 [3.543]	93.5 [3.681]	97.5 [3.839]	101.5 [3.996]	107.5 [4.232]	111.5 [4.390]	115.5 [4.547]	121.5 [4.783]	125.5 [4.941]
Inlet	C	15 [0.591]	15 [0.591]	20 [0.787]	20 [0.787]	20 [0.787]	20 [0.787]	20 [0.787]	20 [0.787]	20 [0.787]
	D	40 [1.575]								
	E	M6								
Outlet	c	15 [0.591]								
	d	35 [1.378]								
	e	M6								

#### Model code example and maximum shaft torque

Flange/drive gear	Model code example	Maximum shaft torque
A9BJ	SNP2NN/011RNA9BJP1C7C3NNNN/NNNN	150 N·m [1328 lbf·in]

For further details on ordering, see *Model Code*, pages 8÷9.

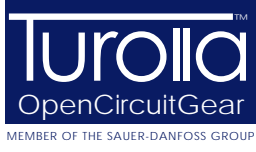

Group 2 Gear Pumps  
Technical Information  
Notes

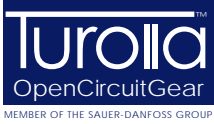

## Our Products

Aluminum Gear Pumps

Aluminum Gear Motors

Cast Iron Gear Pumps

Cast Iron Gear Motors

Fan Drive Gear Motors Aluminum

Fan Drive Gear Motors Cast Iron

## Turolla OpenCircuitGear™

Turolla OCG, with more than 60 years of experience in designing and manufacturing gear pumps, gear motors and fan drive motors of superior quality, is the ideal partner ensuring robustness and reliability to your work functions.

We are fast and responsive - the first to specify a customer product, the most experienced in providing technical knowledge and support for fan drive solutions.

We offer a lean value chain to our partners and customers and the shortest lead time in the market.

Turolla OCG is member of the Sauer-Danfoss Group.

### Local address:

**Turolla OpenCircuitGear**

Via Villanova 28  
40050 Villanova di Castenaso  
Bologna, Italy  
Phone: +39 051 6054411  
Fax: +39 051 6053033

**Turolla OpenCircuitGear**

Kukuřínova 2148-84  
01701 Považská Bystrica, Slovakia  
Phone: +421 424 301 544  
Fax: +421 424 301 626

**Turolla OpenCircuitGear**

2800 East 13th Street  
Ames, IA 50010  
USA  
Phone: +1 515 239 6000  
Fax: +1 515 239 6618